



RMS QUEEN MARY

OWNERS: CUNARD WHITE STAR LINE LTD

BUILDERS: JOHN BROWN, CLYDEBANK

Table of Contents

1	Overview of machinery spaces	6
1.1	Boiler rooms	6
1.2	Oil bunkers	6
1.3	Kerosene fuel bunkers	6
1.4	Propulsion engines	6
1.5	Main steam piping (Figure 1)	6
1.6	Gearboxes	9
1.7	Electrical power generation	9
1.7.1	Emergency generating sets	9
1.7.2	Emergency Switchboard	9
1.7.3	Main Turbo-Generator sets	11
1.7.4	Main switchboard distribution	11
2	Going on board	12
2.1	Blowing a boiler level gauge	16
3	Firing up the auxiliary boilers	18
3.1	The electric oil fuel pumping unit	18
3.2	Lighting Up	20
4	Hotel turbo generator start up	22
4.1	Before we start – a few basics	23
4.2	Starting the TG auxiliary pumps	24
4.2.1	Auxiliary Seawater Pump and Air Pump	24
4.2.2	DB pump, Makeup Pump, Hotwell and Turbo feed pumps	25
4.3	Auxiliary feed system	26
4.3.1	TG main seawater circulating pump	27
4.3.2	Condensate Extraction Pumps (Pervac Pumps) and Air Ejector – Port Turbo Generator	29
4.3.3	Turbine Lubricating (LO) Pumps	30
4.3.4	The Juggling Act	30
5	Firing a main water tube boiler	32
6	Main Turbo Generator start up	34
6.1	The Main Generator steam, feed and condensate system	35
6.2	Starting the seawater circulating pumps	35
6.3	Pervac condensate extraction pumps	36
6.4	Starting the Air Ejectors	36
6.5	Starting the turbine LO pumps	36
6.6	Starting the turbine	37
7	The Main Propulsion Feed System	37
7.1	The feedwater heaters	37
7.2	Turbo Main Feed Pumps	38
7.3	Condenser level controllers	38
7.4	Boiler feed water regulators	38
7.5	Hotwells and feedwater tanks	38
7.6	Assistant DA feed pumps	38
8	Main engine auxiliaries	40
8.1	Main seawater pumps and valves	43
8.2	Air ejectors	44
8.3	Turbo main feed pumps	45
8.4	Turbine LO pumps, coolers and auxiliary seawater circulating pumps	45
8.5	Pervac extraction pumps	46
8.6	Lining up the feedwater system from main feed pumps to the boilers	46
9	Turning the main engines	48
9.1	The turning gear	48
9.2	Main propulsion turbine starting sequence	50

9.2.1	<i>Gland Steam</i>	50
9.2.2	<i>The main stop valves</i>	51
9.2.3	<i>Trial ahead and astern movement</i>	52
10	Getting under way	55
10.1	Throttle v Nozzle Governing.....	57
10.1.1	<i>Throttle governing (steam turbine generators)</i>	57
10.1.2	<i>Nozzle governing</i>	57
10.2	Handing over the 4-8 watch	58
11	The Movement Book	60
12	The Engineers accommodation	60
13	The Forward Engineeroom	63
14	Boiler rooms and auxiliary systems	65
14.1	Boiler rooms 2 to 5 – steam, feed and condensate.....	65
14.2	Auxiliary (No1) Boiler Room and forward hotel generator steam, feed and condensate systems.....	66
14.3	The steam, feed and condensate system for the whole ship.....	67
14.4	Other views from various web sites.....	68

Figure 1 Plan of steam piping in enginerooms	8
Figure 2 Emergency Generator set.....	9
Figure 3 Example of a DC Emergency Switchboard.....	10
Figure 4 Emergency distribution system.....	10
Figure 5 Main switchboard distribution	11
Figure 6 - showing the dry-dock entries in the hull aft above the port outer propeller	12
Figure 7 Dry-dock openings on F Deck.....	13
Figure 8 Routes through to Boiler Room 4 on H Deck.....	13
Figure 9 - Boiler Room 1 (A1 B1, C1) right – Plan (Boiler Room 2 left).....	14
Figure 10 - Section of No1 Boiler Room, looking aft.....	14
Figure 11 - Boiler Room 1 (right) – Elevation (boiler room 2 left).....	15
Figure 12 - Engineer's Lift to B Deck Emergency Generator Room.....	17
Figure 13 - Aft B Deck detail	17
Figure 14 - Boiler Fuel Oil schematic.....	19
Figure 15 - Fuel Oil Pumping Unit	20
Figure 16: Steam trap with connection to drain lines - © Spirax-Sarco	22
Figure 17: Steam trap in action - © Spirax-Sarco	22
Figure 18 - Sectional view of Turbo Generator.....	23
Figure 19 - Forward TG Room Plan.....	24
Figure 20 - Forward TG Room - looking forward	24
Figure 21 - Auxiliary Condenser Reciprocating Centrifugal Seawater Pump.....	25
Figure 22 - Not quite enough water in the dock yet... ..	25
Figure 23 - Duplex and Simplex Double Acting Feed Pumps	26
Figure 24 - Closed feed system (auxiliary hotel generators)	27
Figure 25 - DC Faceplate Starter	28
Figure 26 - Weir 3-stage Air Ejector	29
Figure 27 - Weir turbo main feed pump.....	31
Figure 28 - No 2 Boiler Room Plan	32
Figure 29 - After Turbo Generator Room	34
Figure 30 - Main generator turbine steam and feed schematic	35
Figure 31 - LO pump starters and pumps.....	36
Figure 32 - Plan and elevation of enginerooms.....	41
Figure 33 - Section at Fr 90, looking forward	42
Figure 34 – FR 98 Looking aft.....	43
Figure 35 – Fr 108 Looking aft.....	43
Figure 36 – A pair of main seawater pumps in the workshop.....	44
Figure 37 – Fr 108 Looking forward.....	44
Figure 38 – warming through line on main valve.....	45
Figure 39 - A row of DC starter boxes mounted on the bulkhead	45
Figure 40 – Weir Pervac extraction pump.....	46
Figure 41 – AER Steam, Feed & Condensate system.....	48
Figure 42 – Starboard after turbine set in the erection shop.....	49
Figure 43 – Starboard after nozzle bank today – on top of HP turbine.....	49
Figure 44: Gland sealing system.....	50
Figure 45 - AER Bulkhead Stop Valves.....	51
Figure 46 - FER Starting Platform.....	52
Figure 47 - Shaft Revolution Indicator.....	53
Figure 48 - Astern control chest.....	54
Figure 49 - AER Starting Platform 1934.....	54
Figure 50 - AER Starting Platform today.....	55
Figure 51 - Throttle Governing.....	57
Figure 52 - Nozzle Governing (<i>Sideplayer.com</i>)	57
Figure 53 - One of the shaft tunnels - a gloomy place	59

Figure 54 - Senior Engineers Accommodation and Wardroom on Sun Deck	60
Figure 55 - Cunard Officer's Mess Kit.....	60
Figure 56 - Junior Engineers Accommodation on E Deck.....	61
Figure 57 - Engineers Messroom and Provision Cold Rooms on D Deck	61
Figure 58 - The Burma Road - Working Alleyway, Port side D Deck	62
Figure 59 - The Burma Road running through the ship on D Deck	62
Figure 60 - Forward Engineroom Steam, Feed and Condensate diagram	63
Figure 61 - Section at Fr 116 looking aft (FER).....	63
Figure 62 - Section at Fr 134 Looking Forward (FER).....	64
Figure 63 - FER starting platform.....	64
Figure 64 - Boiler rooms 2 to 5 and Main TG room	65
Figure 65 - Auxiliary boiler room No1 and hotel TG room	66
Figure 66 - Duplex and Simplex steam feed pumps.....	66
Figure 67 - The complete steam, feed and condensate drawing	67
Figure 68 - Boiler Room 1 - burner front of Scotch boiler	68
Figure 69 - a propulsion boiler in Boiler Room 2 undergoing maintenance	68
Figure 70 - Boiler room 4 in the process of destruction at Long Beach.....	69
Figure 71 - Boiler Room 5 in good condition	69
Figure 72 - The steering Gear room today.....	70
Figure 73 - The Steering Gear Telemotor showing the hand wheel from the after flying bridge.....	70
Figure 74 - The Steering Gear Switchboard.....	71

1 Overview of machinery spaces

1.1 Boiler rooms

The ship is a quadruple screw Cunard liner fitted with three double-ended Scotch fire-tube boilers in Boiler Room 1, working on the closed ash-pit principle under forced draught. At a working pressure of 250lb/in², 200F superheat, these boilers are used for starting the vessel up from cold and for maintaining the hotel services generators in port when the main propulsion boilers are shut down.

The propulsion boilers comprise 24 Yarrow 5-drum water-tube boilers, operating at 400lb/in², 700°F superheated. The boilers are situated in Boiler Rooms 2 to 5, as shown in the plans reproduced later in this document, those in Boiler Rooms 2 & 3 being smaller than those in Boiler Rooms 4 & 5.

The boilers are arranged in 5 boiler rooms, separated by turbo-generator rooms between Boiler Rooms 2 & 3, and 4&5.

1.2 Oil bunkers

The boiler oil fuel bunkers are arranged longitudinally either side in the boiler rooms, and comprise overflow and settling tanks in the double sides of the vessel in way of the boiler and turbo generator rooms up to the level of F Deck. The oil-firing or burner pumps are arranged within each Boiler Room.

1.3 Kerosene fuel bunkers

Kerosene for the emergency generators is stored within the Emergency Generator space, sufficient for 36 hours running.

1.4 Propulsion engines

The propulsion system differs from the older vessels in this series as the turbines are arranged for quadruple expansion in each of four turbine sets – one set of two in the forward engine room, and one set of two in the after engine room. The turbine sets each comprise an HP (high pressure), two IP (intermediate pressure) and one LP (low pressure) turbine working each shaft. HP astern turbines are fitted on all four turbine sets within the 2nd IP turbines, and all four LP turbines also have astern turbines, allowing astern movements on all four shafts.

The ship has a very comprehensive redundant system for running the turbines together or in isolation, but the normal quadruple-expansion arrangement will be described below.

1.5 Main steam piping (Figure 1)

Boiler Rooms 2 & 4 supply the forward engine room bulkhead stop valves, with boiler rooms 3 and 5 supplying the after engine room bulkhead stop valves, thereby distributing the smaller and larger boilers between the two engine rooms as a set of 6, 3 large and three small.

Steam from these four main steam pipes passes through the turbo generator and boiler rooms and enters the forward and after engine rooms via bulkhead stop valves operated by Brown's engines and governors from the turbines, which shut off the steam supply in the event of turbine overspeed or other fault that could damage the turbines such as low LO pressure.

From the stop valves, the outer steam pipes pass to the two turbine sets in the after engine room via a further set of bulkhead stops, the inner two pipes pass through to the forward engine room bulkhead stops on the forward engine room bulkhead. From the stop valves on both the forward and after engine room bulkheads, the steam passes to the turbine manoeuvring valves in each section.

From the manoeuvring valves the steam passes through each turbine stage and finally exits to the condensers from the LP turbine exhausts.

This exhaust steam from the low-pressure turbines is directed to the four vacuum condensers, situated outboard of each of the after engine room turbine sets, inboard of each of the forward engine room sets, where it is condensed into feed water and pumped back into the boilers.

Regulating/manoeuvring valves, driven by worm and quadrant gear via spindles operated from the starting and manoeuvring platforms, admit steam to the engines as required by the telegraph orders.

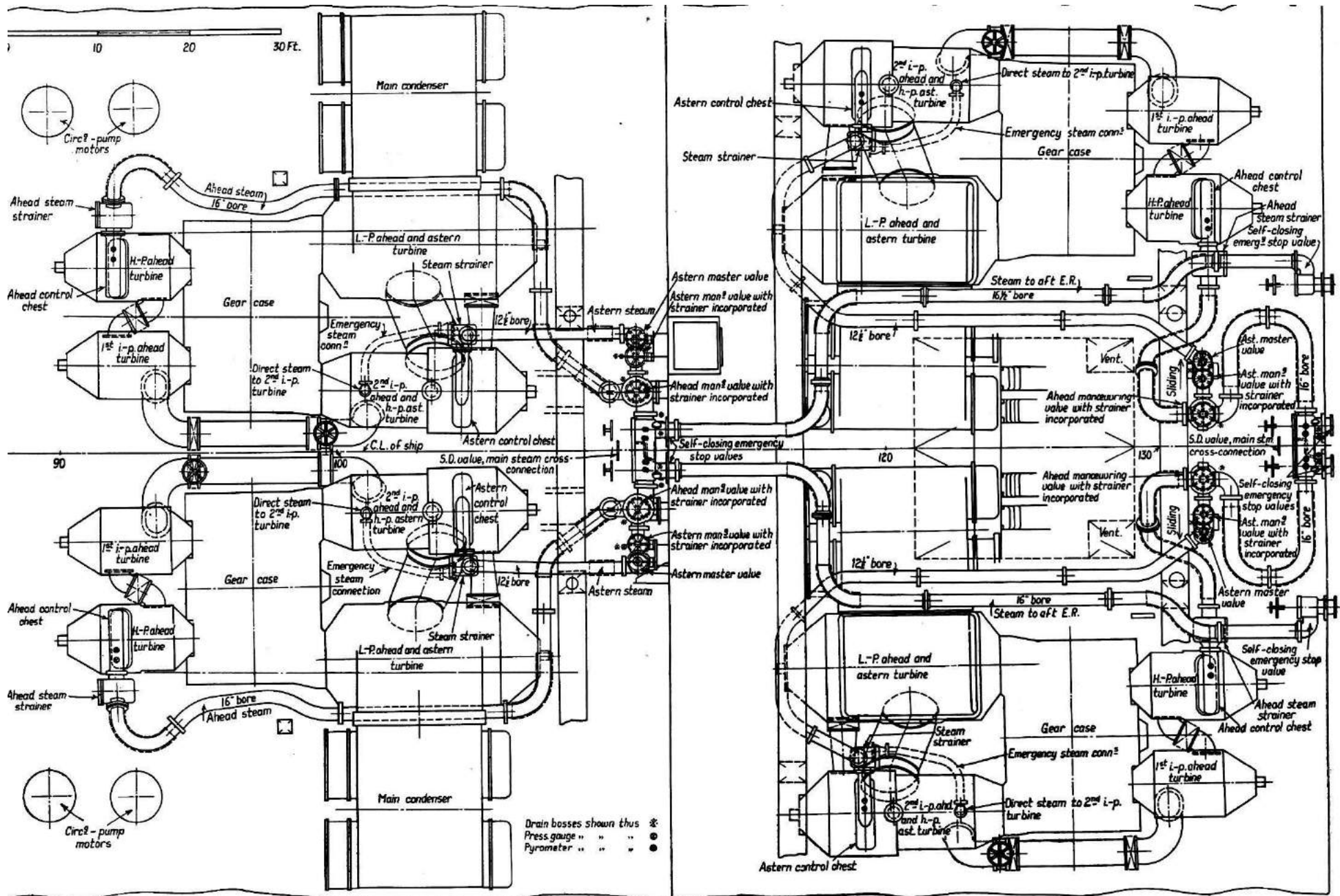

Figure 1 Plan of steam piping in engine rooms

1.6 Gearboxes

Queen Mary has double helical single-reduction gearing via four gearboxes, one for each shaft, to cope with the speed of the turbines under superheated high-pressure steam conditions.

1.7 Electrical power generation

1.7.1 Emergency generating sets

The vessel is fitted with two emergency DC diesel generators of 225V, 75kW each for emergency lighting, wireless telegraphy as well as some power circuits. These machines will be used for cold starting, via the emergency switchboard connections for the FD fans instead of using shore power. We will use them here to get lighting and low power services running so that shore power can be disconnected.

The generators, when running under loss of main power, have a charging capability for the various battery banks. Under normal power the battery banks are charged from the main system.

The generators are electric start, so the engineers would start these machines and put them on the board, after which the shore power breaker can be opened.

Once the engines are started and put on the board, the various circuits required for starting the main generators are energised, up to the capacity of the emergency switchboard. The engines are self-contained and will start immediately on load.

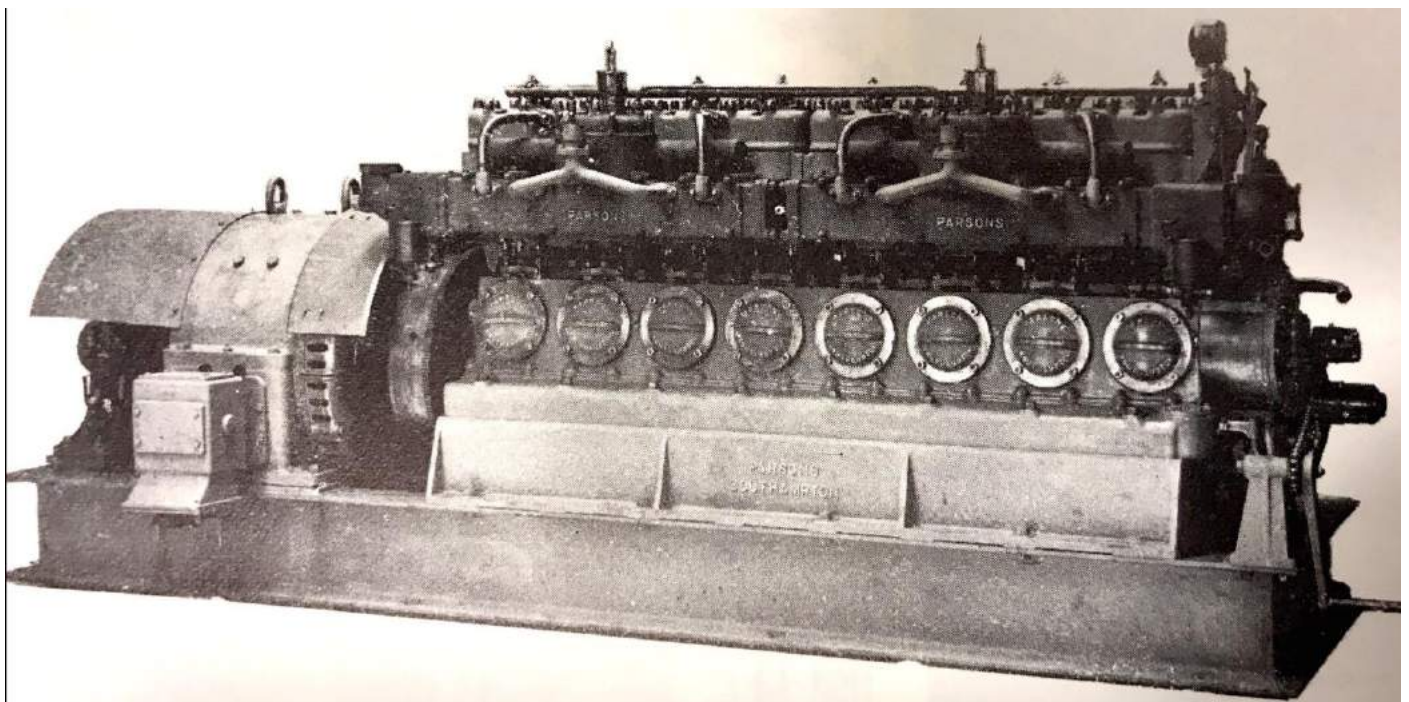

Figure 2 Emergency Generator set

1.7.2 Emergency Switchboard

Attached to this board are the emergency distribution circuits. On this age of ship these are generally confined to –

- Emergency lighting (throughout the ship)
- Transition lighting (stairways, control panels and operating stations)
- Wireless telegraphy
- Small power (probably ventilation fans for accommodation and other hotel services)
- Battery charging

The emergency Switchboard can be switched to either the main propulsion or hotel switchboards for activation of certain items of cold start equipment.

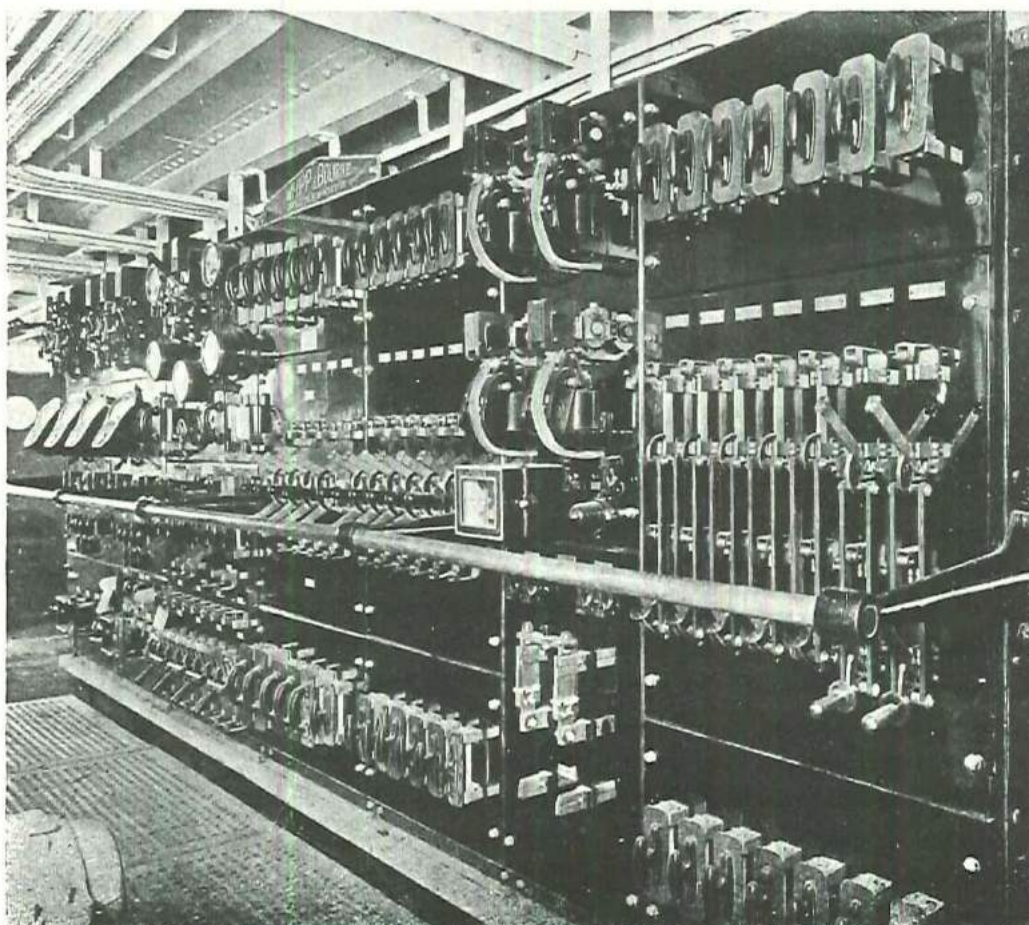

Figure 3 Example of a DC Emergency Switchboard

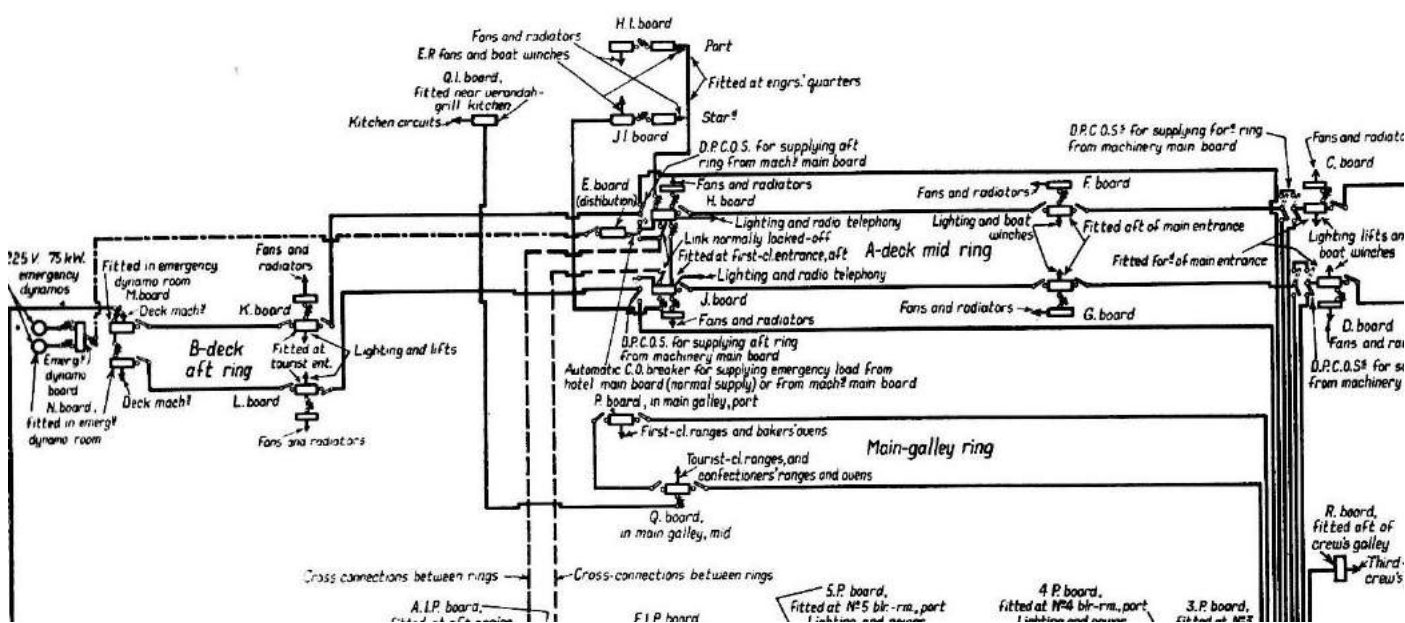

Figure 4 Emergency distribution system

The emergency generators (aft on B Deck) supply power to the main and hotel boards as required, whilst one or both emergency sets are running. Once a main or hotel generator is started and put on the board, the breaker for the emergency generator opens automatically, and connects the main and/or hotel switchboard(s) to the emergency switchboard. This process is instantaneous, such that any electric motors or facilities running on the emergency sets are immediately transferred to the hotel or main switchboards via the ring circuits.

1.7.3 Main Turbo-Generator sets

Main electrical power is generated by a total of 7 single-reduction geared turbo-generators at 5,000rev/min, each of 1300kW at 225Vdc, with the BTH generators at 600rev/min via the gearboxes. These sets are situated 4 in the after main turbo generator room, and 3 in the hotel turbo generator room. The main and hotel switchboards are situated forward respectively in the two turbo generator rooms, with auxiliary boards placed about the ship as required.

Steam at a pressure of 370lb/in² and 680°F is fed to the turbines, which are fitted with their own condensers and auxiliaries to tie in with the ship's main feed and condensate systems. The 3 hotel generators are operated in port off No 1 boiler room Scotch boilers at 230psi at 650°F, with bled steam from the turbines taken for feed heating purposes, whilst the main propulsion boilers are shut down. This configuration gives a total installed power of 9.1MWdc, with adequate stand-by redundancy.

1.7.4 Main switchboard distribution

The main and hotel switchboards are divided into sections and ring mains in order to distribute the power to the various areas of the ship. Most of the auxiliaries are electric drive and the breakers for these can be seen on the board. On Direct Current the breakers for the generators (all 7 are shown on the diagram) can be put straight on to the board (with the shunt field regulator wound right down) as there is no need to synchronise as with an alternating current system. The shunt field regulator is then wound up to share the load with the other generators on the board.

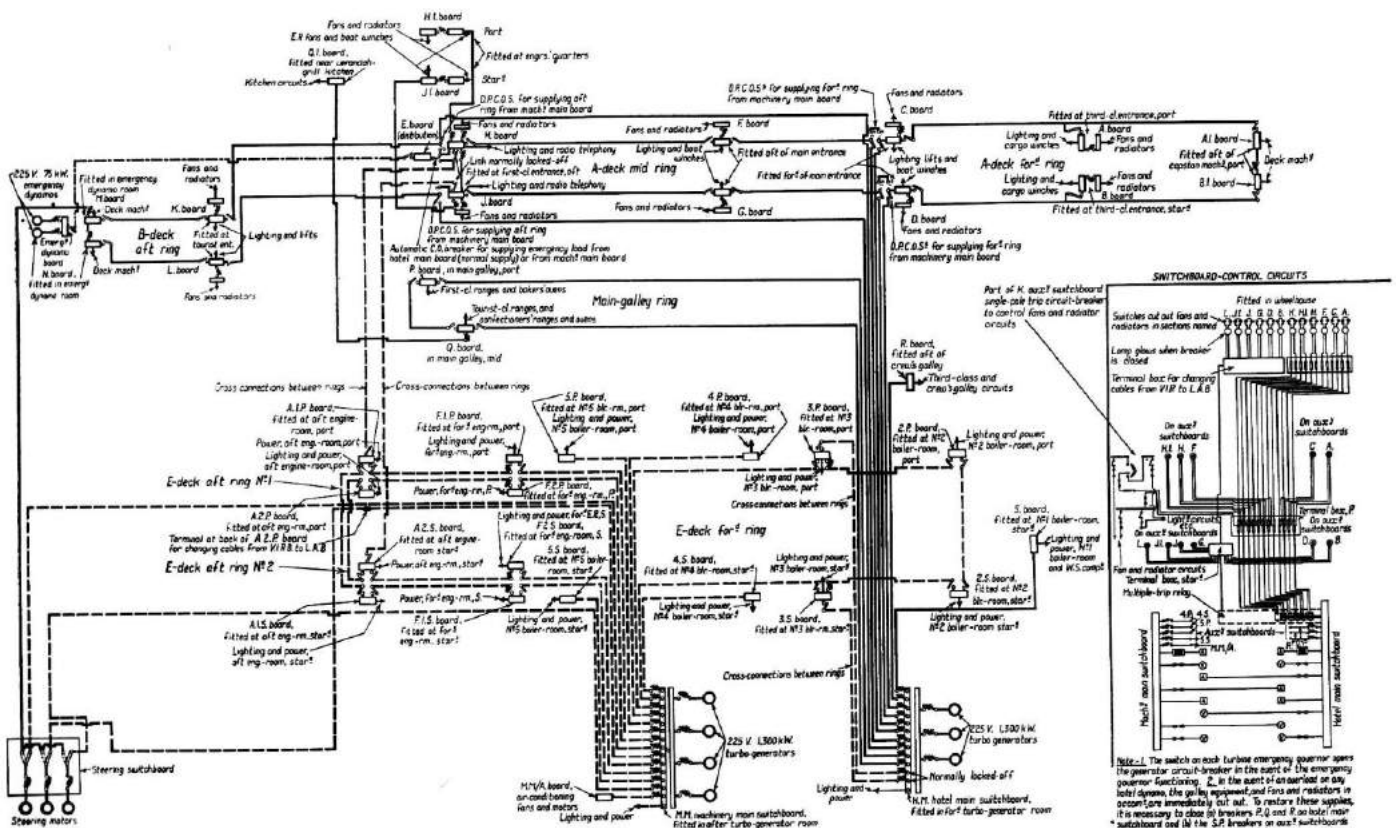

Figure 5 Main switchboard distribution

2 Going on board

The ship is currently in dry dock undergoing repairs, so our job is to start getting her ready for coming out of dry-dock and alongside her berth. You and I will be changing over from shore power to ship's power, firing boilers and starting steam turbine generators, but we have a lot of help to do it. There's a lot to do in the way of familiarisation (the ship is huge) so we will go on board via the quickest entry point, which is the after dry-dock opening in the port side of the ship. This and the exit door are opened to allow access to the machinery spaces when in dry-dock, and riveted shut again once the opening is no longer required prior to flooding up the dry-dock. We are already in boiler suits and boots, our gear having been stowed in our cabins by a steward.



Figure 6 - showing the dry-dock entries in the hull aft above the port outer propeller

Note: These openings are used for the "Propeller Box" built on to the side of the ship in Long Beach.

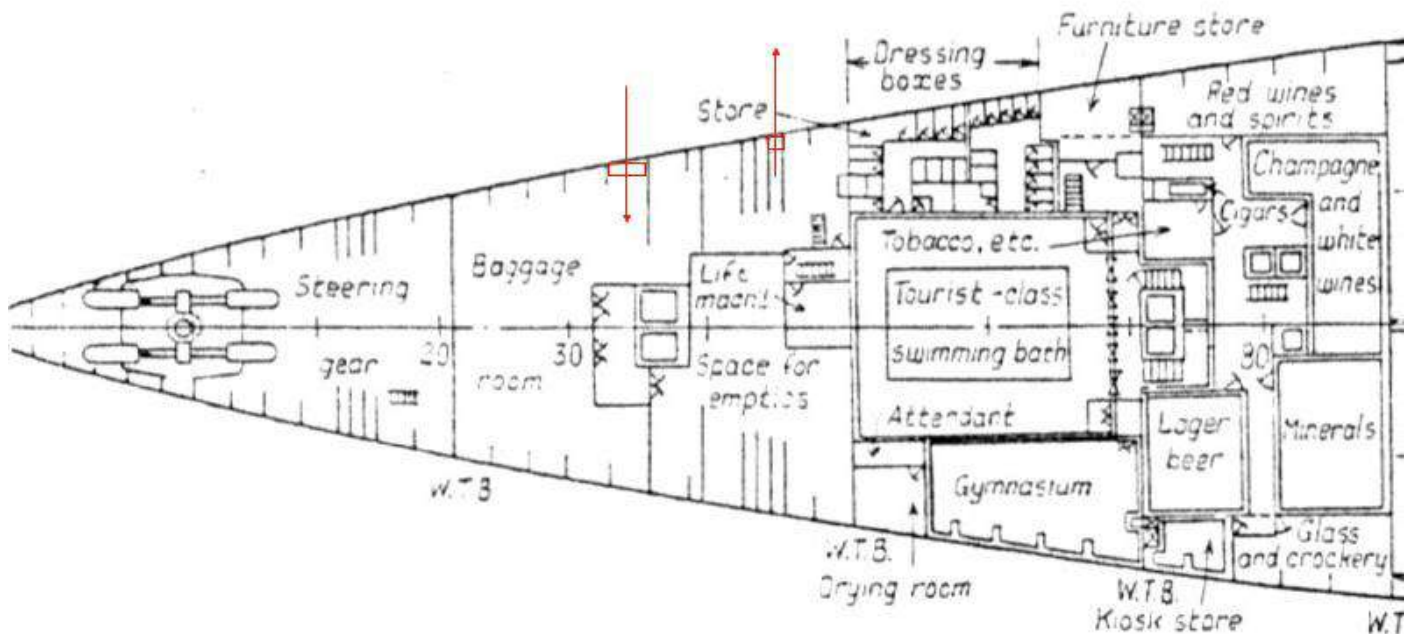

Figure 7 Dry-dock openings on F Deck

From here we take the ladders down two decks to H Deck, which brings us to the port outer shaft tunnel, from which we can walk forward into the after engine room and from there via the WT door into the forward engine room and thence through the air locks into Boiler Room No5, the after turbo generator room, Boiler Room 4 and beyond.

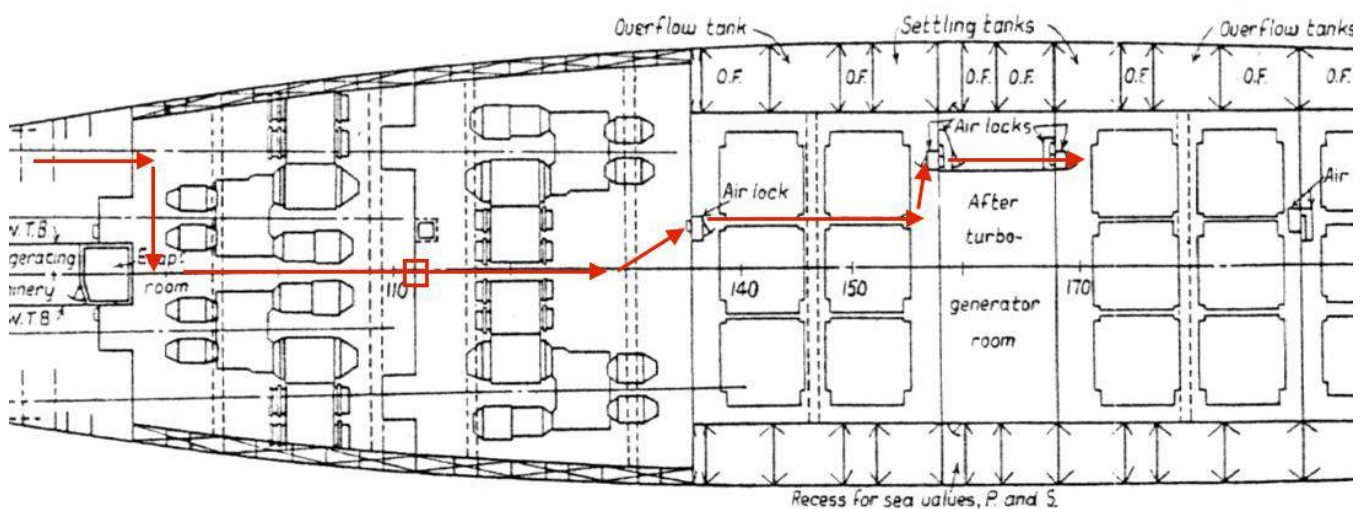

Figure 8 Routes through to Boiler Room 4 on H Deck

From Boiler Room 4 we carry on forward through Boiler Room 3, the forward Turbo Generator room, Boiler room 2 and finally into Boiler Room 1, where we will start getting things ready. We have passed through all these spaces via the air locks, which are either side of the raised watertight doors in each WT Bulkhead. We will come back to these spaces later and get familiar with the equipment in each. Currently the boiler rooms are all more or less cold from the dry-dock period, so it takes some time to get the ship up to the point where we can consider going to sea. It's still a bit chilly here in September in Southampton, and this has permeated below decks, where the rooms we have passed through have only been lit sporadically via the emergency lighting powered off the Shore Power. There's a smell of fuel oil about the place, and paint from new lagging sections on steam pipes. If we look up as we pass through, we can see the large white-lagged steam pipes that run through all these spaces to the engine rooms and turbo generator rooms, which supply steam to generators and main propulsion turbines.

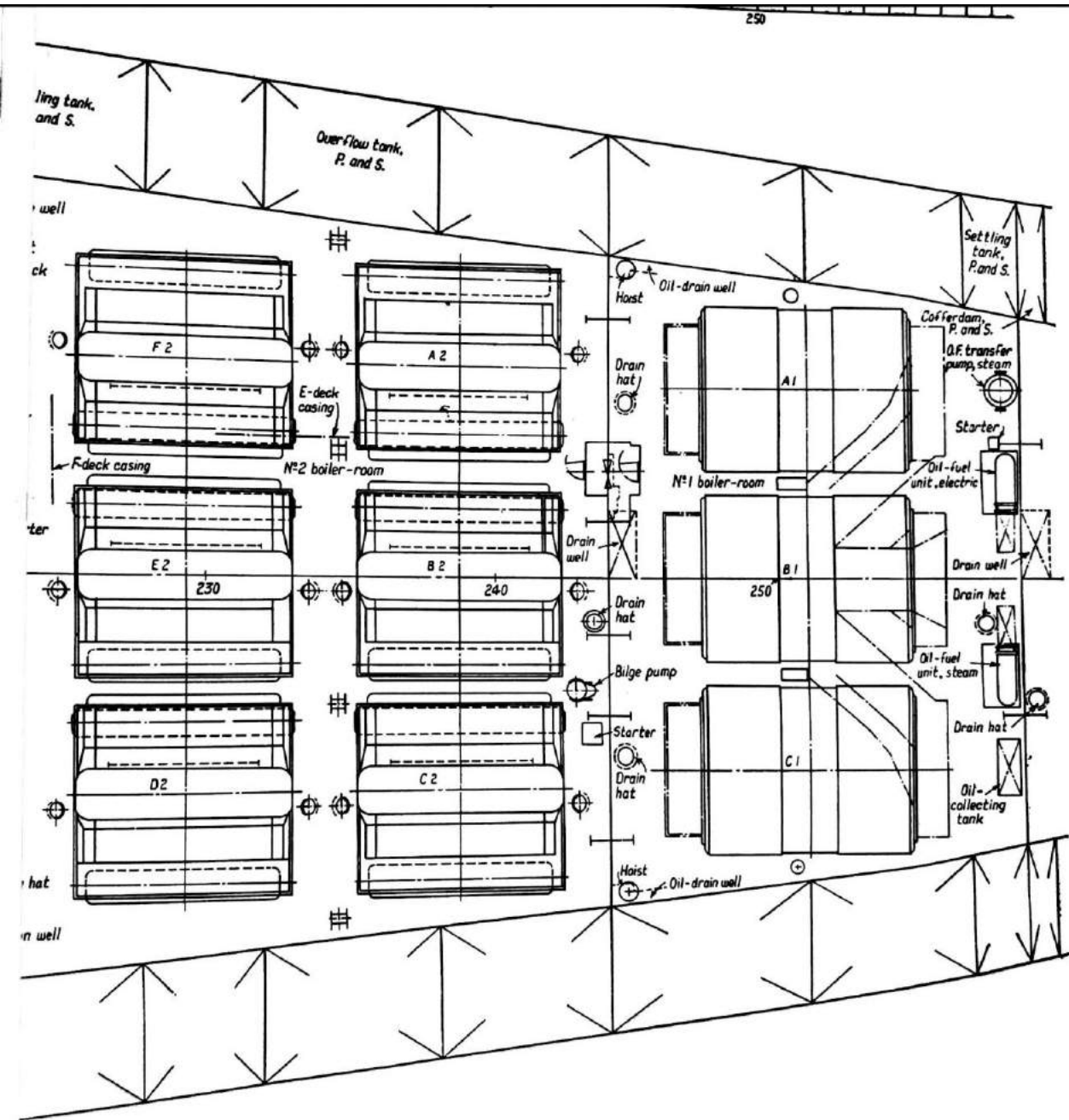

Figure 9 - Boiler Room 1 (A1 B1, C1) right - Plan (Boiler Room 2 left)

Here we are in Number 1 Boiler Room, and if we look about us, it's pretty much filled with three double-ended Scotch boilers. Auxiliary equipment provided in the space can be seen in the plan above and elevation below and which are, starting from the air lock door we've just come through -

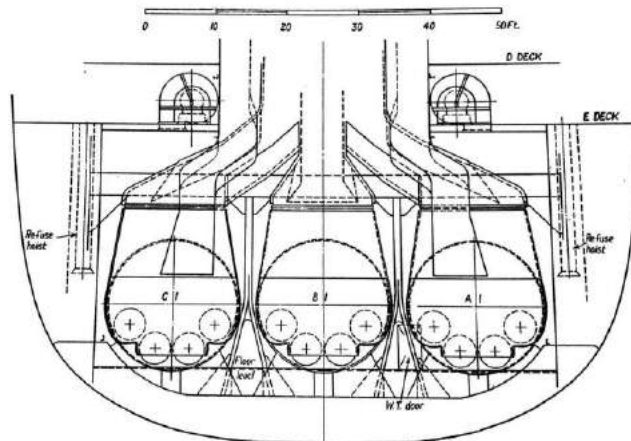

Figure 10 - Section of No1 Boiler Room, looking aft

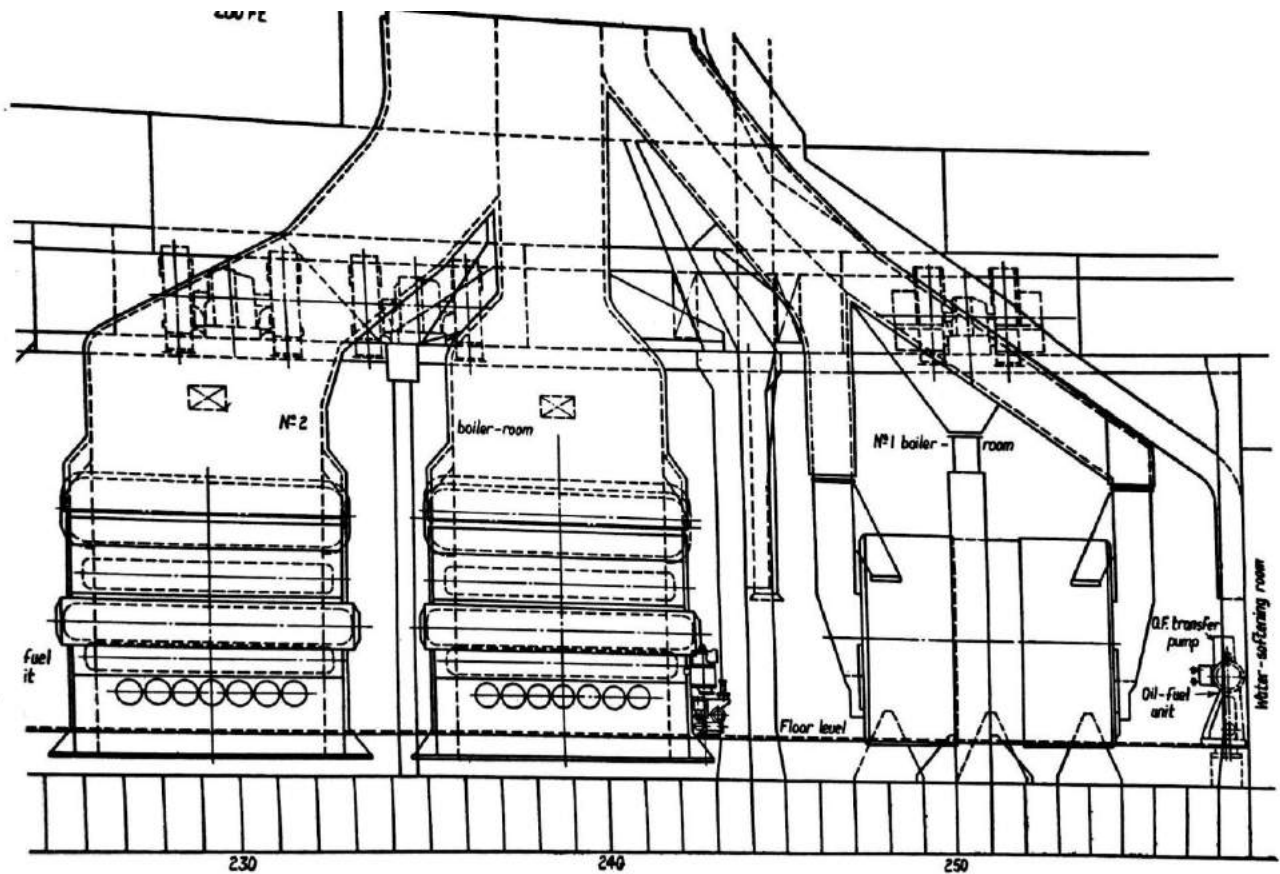

Figure 11 - Boiler Room 1 (right) - Elevation (boiler room 2 left)

- To either side of us, outboard close to the side port and starboard are the ash-hoists, used for hoisting carbon and rubbish from boiler cleaning operations to higher in the ship for disposal overboard. In the old coal-burners, these ash hoists blew the ashes over the side, but these oily residues have to be disposed of ashore or when out at sea. *Note: Nowadays this is not allowed under pollution regulations.* The burner doors of the boilers are in front of us on each boiler, and we'll come to them later.
- Walking between boilers A1 and B1 to the forward bulkhead, we see to port and in front of A1, an Oil Fuel Transfer Pump driven by an electric motor, which is used to pump oil from storage tanks to settling tanks, where any water and sediment can be drained off.
- Inboard of the OF Transfer Pump and right in front of us is the electric cold start boiler fuel oil pump and heater, which we will need shortly as there is no steam available for steam heating of the fuel oil. The pump draws oil from the Settling Tanks and discharges it to the boiler fuel common rails and burners.
- To starboard of us is the steam heated boiler fuel oil heater, which we will use once we have steam up on the Scotch boilers. It also has an electric motor driven pump.
- Looking above us we see two forced draught fan units on Fr.250, which we will need to start once we have enough power from the emergency generators to take the load. The two sets of fans are driven by a central motor and supply the forced draft for all three boilers. The speed of the fans, and therefore the volume of air supplied, is controlled by the DC starters used to start the fans. As more boilers are fired, the speed of the motor can be increased via the shunt field regulator.

In this boiler room are a couple of firemen, tasked with helping us in getting everything started. First we go to check the boiler water levels in all three boilers to make sure there is at least 1" in the glass. If there is no water showing in the glass, we can use the softened water tank (situated in the water softening plant room forward of Boiler Room 1, which has pumps we can use to fill the boilers (with

no steam pressure) via a filling cock on the top of the steam space. The firemen know how to do this for any boiler that has no water showing in the glass.

We do however need to check if the gauge glasses are clear, and there is a routine for doing this, which every marine engineer knows. It's often a question in the orals for examination of engineers at the Board of Trade, and if you don't know it, you won't pass, and all your written papers go in the bin, with you being awarded another 3 months sea time before going up for you ticket again! Here's how it's done -

2.1 Blowing a boiler level gauge

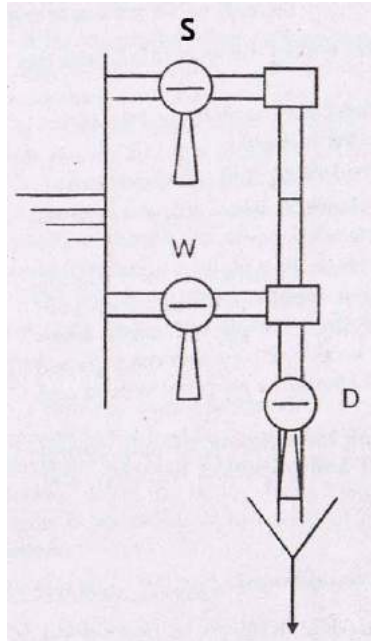

Where -

S Is the Steam cock

W Is the Water cock

D Is the Drain cock

- Close off cocks 'S' and 'W' and open drain 'D'. Make sure both water and steam cocks are holding. The water level should drop out of the glass. If it doesn't, the drain cock is blocked and you would have to fix it. If water (or steam when the pressure is up) continues out of the drain, you will have to fix the valves. They've been overhauled in dry-dock so we should have no problems in that direction.
- Open cock 'W' and blow through. Make sure that water is coming out of the Drain to show cock 'W' is clear. Close water cock. The water comes out of "D" as a mixture of water and steam and is quite noisy when the boiler is on load.
- Open cock 'S' and blow through with steam (which we don't have at the moment). Make sure that steam is coming out of the Drain to show cock 'S' is clear. Leave the cock open (You can also close steam cock at this point, but any unnecessary opening and closing of the cocks can result in the packing leaking, which you would have to replace)
- Close drain 'D'.
- Open water cock 'W' and check that the water level rises smartly up the glass.
- (Open steam cock 'S' if you closed it in bullet 6).

We find one of the boiler levels is below the glass, and send the firemen off to fill it from the softened water tank.

Note: There is an auxiliary feed tank in Boiler Room 1 (shown on the steam, feed and condensate schematic), which may be high enough to run down under gravity but it's not shown on the plan or elevation drawings. Most if not all steamships of the period also had an electric motor driven "cold start" feed pump to get water into the boiler, but again this is not shown in either the text or drawings of the reference book on the ship. The boiler rooms are sitting on the double bottom, which has reserve feed water tanks for the length of the boiler spaces, situated port and starboard of the centreline under each boiler room, from which water is drawn to make up any losses in the feed tanks situated in the enginerooms.

We are just about done here until we can get power on, so off we go for a rather long jaunt to the emergency generator room on B Deck aft. We could climb up the ladders to B Deck from Boiler Room 1 and then walk aft, but we are not really supposed to be strolling through passenger accommodation, so will retrace our steps back to the forward engineroom, and take the engineer's lift that runs up to the Senior Engineers' cabins on the Sun Deck, though we will hop off at B Deck port side working alleyway.

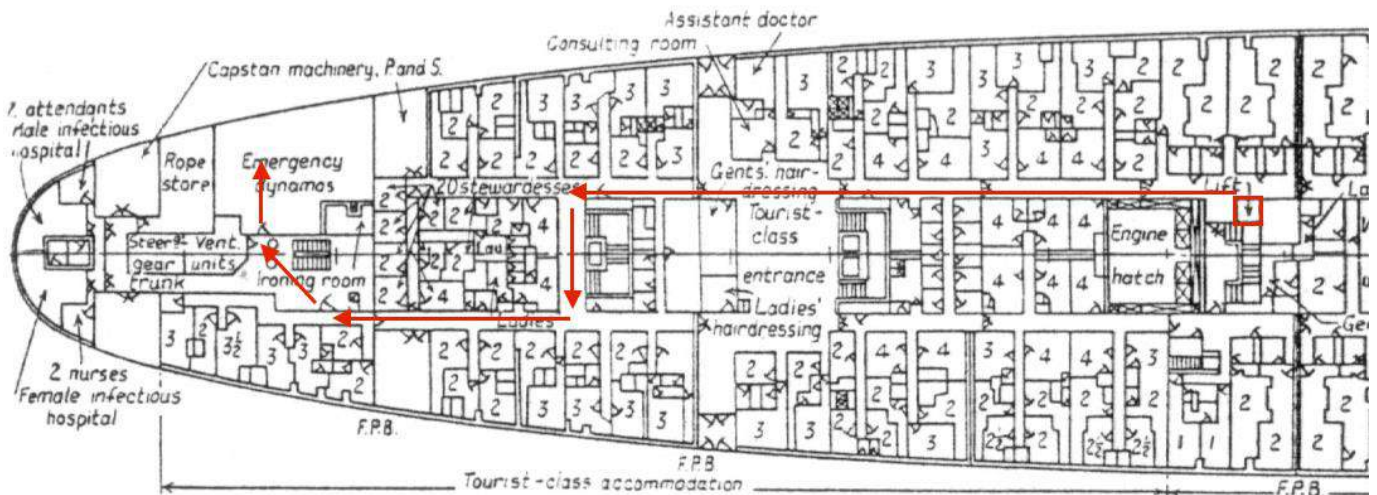

Figure 12 - Engineer's Lift to B Deck Emergency Generator Room

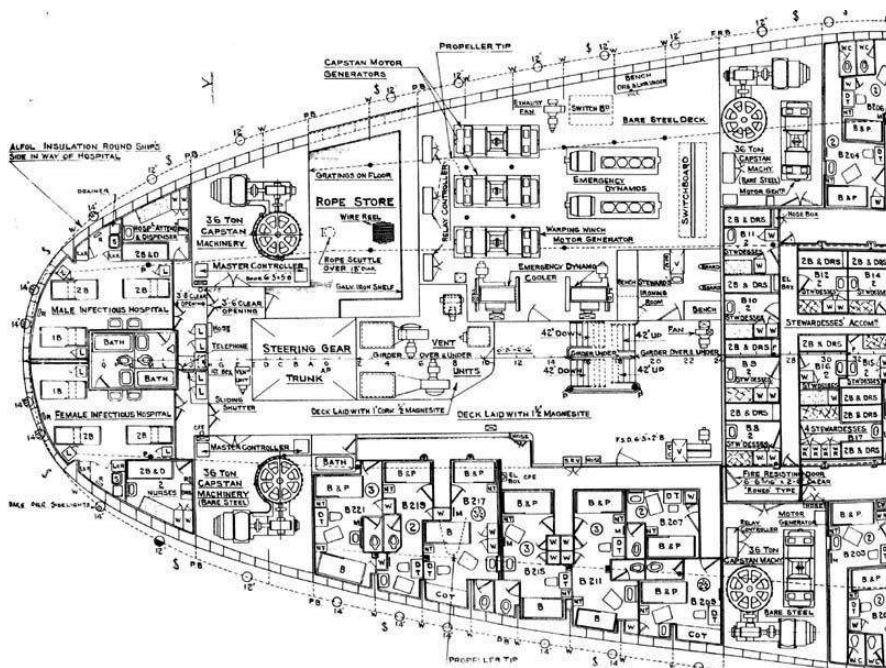

Figure 13 - Aft B Deck detail

This is quite a cunning route as it takes us past the accommodation for stewardesses and other ship's girls who work in the hairdresser's and the various smart shops in the passenger areas. In some companies it's known as "Fluff Alley" and is usually pervaded by a cornucopia of perfume aromas "liberated" by the ladies from the perfume counters. It always seems to be party time down here... Unfortunately none of them are on board at the moment as the ship is still in dry-dock, so you will have to use your imagination for now, but you know where it is for future reference...

As mentioned earlier, there are two 75kW engines and their respective generators in this space which is shared with the after deck mooring capstan and warping winch motor-generator sets and a pair of coolers for the emergency generators. There is also an exhaust fan, which we will start up to ventilate the space.

The generators are 8 cylinder machines running on kerosene with an output of 75kW each via the 225V DC generator. **Note:** *Nowadays a similar size of engine would be a turbocharged unit developing around 800kW on alternating current, running on marine gas oil (MGO); things have come on since the 30s.*

We check the usual water and oil levels (as you would have done in your car in the 30s to 60s during the life of this ship) and open up the fuel valve from the kerosene tank. The emergency switchboard in the room is lined up to the main and hotel switchboards such that we can use it for supplying any circuit on these boards. In our case we will use the feeder to allow power to Boiler Room 1 only, as we only need to start the forced draft fan, boiler fuel oil pump and electric heater using emergency power, after which, and with steam on the boilers, we can start one or more turbo generators – but more of that later.

The engines are battery start, so after barring the engine over with the barring gear (to make sure there's no water or fuel remaining in the cylinders), priming the LO system with the hand pump, we press the start button and the engine cranks over before starting. Kerosene is quite a light fuel and the engine starts easily. There is enough in the tanks for 36 hours, of which we won't need more than around 12 hours to get a boiler up to steam, after which the tanks will be replenished by the "Tanky" whose job it is to keep such tanks filled at all times. It's quite noisy in here now, as we check that the cooling fan is running (off the generator terminals) after which we close the breaker to the main supply and open the shore power breaker to allow the dry-dock staff to detach and remove the shore power cable. Without a turbo generator running, we can back-feed into the ring mains. However once a main generator is started, the emergency generator breaker opens and the main system supplies the emergency circuits automatically. Again, on failure of the main system, the emergency generators will start and connect to the main system via a relay. All very impressive for a 30s ship, and it makes our job easier as the electric motors and heaters that are running on the emergency supply will stay connected when the supplies change over. More of that later, as we start the other engine in the same way then head back to the lift, take it down to the forward engine room and walk back through to No 1 Boiler Room.

3 Firing up the auxiliary boilers

We now have enough power available to start the forced draught fans from the starter adjacent to the fans above the boilers. We start the fan on low speed and wait until it reaches a steady speed, after which we can let go of the starter device and wind up the shunt field regulator to increase the speed of the fans. We will keep them on low speed for the first boiler flashed, and increase it as we need more forced draught with other boilers fired.

3.1 The electric oil fuel pumping unit

Once the air is established we then instruct the firemen to start up the boiler oil pump and start circulating the oil from the fuel oil settling tanks to the pump suction strainers and into the pump, which then discharges through the heater. The firemen will use the electric heater and pump unit for starting the system because we have no steam available for the main heater; it's known as a "cold

start” pump and heater. After a suitable warming through period, hot oil will then be available at the boiler burner rail. The pump pressurises the rail to around 16bar by means of a pressure-regulating valve (PRV), to ensure that the burner rail pressure remains constant at all times. From the PRV the fuel goes back to the pump suction upstream of the heater. The pump capacity is some 16.7m³/hr or 15t/hr, which is 360t per day delivery, though actual consumption would be less than that. Here’s a sketch of a typical boiler fuel circulation diagram –

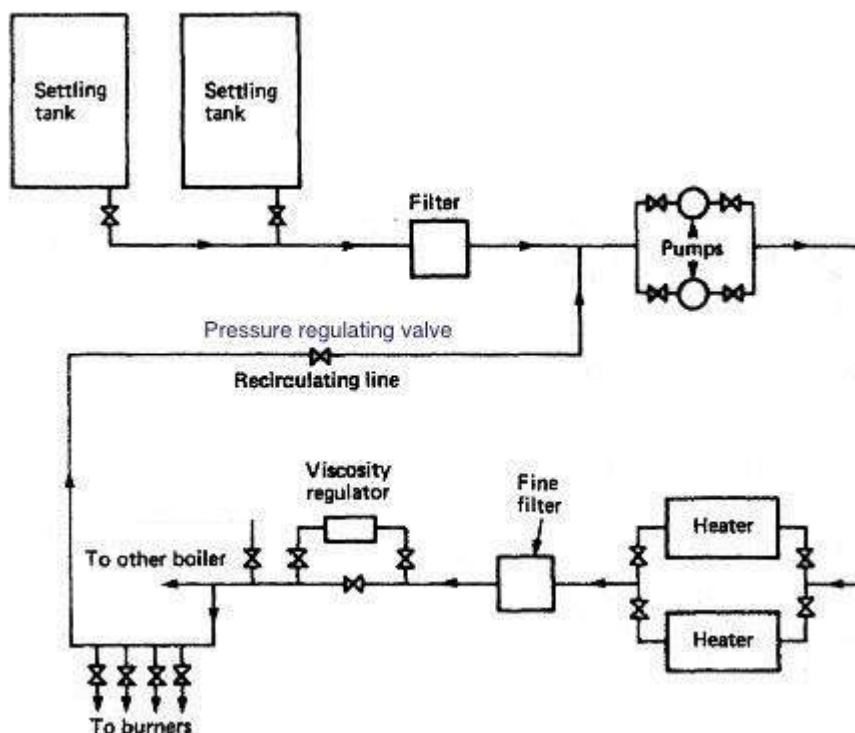

Figure 14 - Boiler Fuel Oil schematic

The fuel comes from the settling tank and via a suction strainer/filter into the fuel pumps, which discharge it through the heater and fine filter to remove any impurities that may block the burner tips. Whether Queen Mary had a Viscosity Regulator is not known, but this device if fitted would measure the fuel viscosity and either increase or decrease the heat applied by the heaters. The fuel then enters the fuel rail, which supplies all the burners in the boiler system, with a spur to the other boilers supplied by the same pumping system. The pressure builds up in the line, and is vented via the backpressure valve – or a manual valve as shown in the diagram – back to the pump suction. It is likely that with so many boilers, Queen Mary would have an automatic pressure regulator in place of this valve to keep the fuel pressure steady at 230psi (16bar).

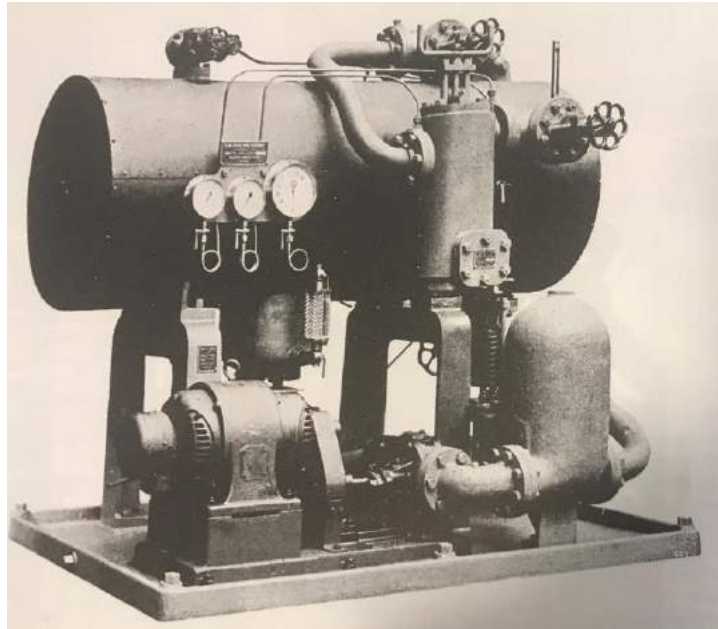

Figure 15 - Fuel Oil Pumping Unit

Whilst this is happening, we climb the ladders to the top of the boilers and open the main stops, which are the isolation valves from the steam drum and superheater. At the same time we open the superheater-starting valve so that when steam is raised there is a path through the superheater tubes to avoid them overheating before we can get a turbo-generator running (this is just a valve that leads the steam to the bilge – it makes a racket, though is sometimes fed through a silencer or cooler). We then go to the electric starter for the forced draft fans and wind their speed up to give the right furnace pressure – it's quite noisy and we have trouble hearing each other close to them. The fan speed can be regulated to match the draft with the oil quantity to allow smoke-free combustion – and the firemen will control the oil and air volumes to the furnaces as required via primary and secondary air dampers. As we are starting up from cold, it will take some hours to gradually raise steam on the boilers. We will start with around ten minutes of firing every half hour and gradually increase this as the boilers warm through and start to make steam. Raising steam too quickly could cause thermal shock to the boiler internals, which is obviously to be avoided. The Leading Fireman knows what he is doing, and we can leave him to do the job, but may as well watch what he does when lighting up our first boiler.

3.2 Lighting Up

With the circulating fuel up to temperature, the fireman adjusts the draft to minimum for firing on one burner. He has a rod with cotton waste on the end, resting in a pot of paraffin, and a pot with a wick, which he lights with a match. Opening the sight glass on the burner front, he lights the paraffin-soaked cotton waste from the wick and pushes the rod through the sight glass into the furnace with his left hand. With his right hand he starts to open the burner valve; there's a slight "whoof" as the burner lights from the flaming cotton waste, and he withdraws the rod, dunks it back in the paraffin pot (it won't set it alight) and closes the sight glass. Using a skill born of long practice, he adjusts the oil injection and draft to give a straw-coloured flame in the furnace. That's the start for this boiler, and he will keep the burner on minimum modulation for short periods every hour to allow the boiler and water to warm through, gradually decreasing the interval between firing, and increasing the oil volume.

The fireman's job is a lot easier on an oil-burner compared to a coal-burner in that he doesn't have to shovel coal, discharge huge quantities of ash or clean fires every watch, which is a filthy job and very labour intensive. Our fireman above fires the boiler using one of the main burners to warm through, and will cycle through them one at a time to warm the internal brickwork and tubes up evenly. With careful control of the combustion air and fuel, he can ensure a clean flame which is not only more efficient in burning the oil, but also keeps the boiler internals clean which aids in the transfer of heat

from the flame to the water tubes. Dirty tubes can cause local hot spots, which can result in a tube cracking or bursting. Even on an oil-burner the fireman's job is still very important and it takes a skilled man to watch the water levels, steam pressure and flame condition. He also has to know when to withdraw a burner and replace it with a clean one if the oil vaporisation is starting to get ragged. This would cause excessive smoke, which is to be avoided for both boiler conditions, fuel economy and passenger comfort!

The silence in the boiler room is now a thing of the past – the noise of the forced draft fans fills the room, the roar of the flame inside the boiler and the flickering light through the furnace sight glass is evident in all the fired boilers. The fuel-pumping unit is humming away feeding the furnaces with fuel, and there is a smell of hot lagging permeating the space. We are starting to get things going and will move aft through the other boiler rooms to the hotel (forward) turbo-generator room once we have steam to drive them, and all the lines are drained. It will take around 7-10 hours to get all three Scotch boilers up to pressure though, so we can take a break for a while and have a doze in our cabins or familiarise ourselves with the rest of the machinery spaces. Your cabin is on E Deck whereas mine (being naturally a Senior Engineer) is on the Sun Deck via the lift that we used earlier. We will get a call once steam is raised on the boilers.

Note: The propulsion water-tube boilers that we will be firing later are much more efficient and faster starting than fire-tube, but would still take around the same time to raise steam to manoeuvring pressure from cold, so we are in for a long wait. Firing boilers is carried out in stages to avoid thermal shock to the tubes and boiler drums, with the superheater starting valve open, along with the vents on top of the drums to dispel any air. Additionally the main stop on the first boiler (usually furthest away, as are our Scotch boilers in the No.1 boiler room) is open in order to drain the main steam lines as pressure is raised (of which more later when we start the turbo generators).

As the pressure rises and steam is issuing from the steam drum vents they are closed, with the superheater starting valve left open whilst the fires are on to ensure a steam path through the superheater banks to avoid damaging the tubes. We can only close this valve once the fires are stopped or the boilers go on load via the turbo-generators, and our firemen will know this when the boilers start to use more steam and they have to increase the firing rate and feed water flow rate.

As steam is raised on the boiler which has its main stop valve open, the drains along the whole length of the main steam lines to the forward turbo generator room are opened up to drain any condensate, as liquid entering the turbine machinery can cause damage to the blading.

We are dozing in our cabins, and get a "shake" to tell us it's now 12 hours on, and that we have around 230lb/in² at the main stops to the main steam lines into the enginerooms. You will remember that we left the main stop valves of the single-ended boilers open to the main steam pipe during firing in order to bring up the piping temperature to that of these first boilers lit, such that the piping and valve drains clear the lines of condensate, which can damage reciprocating and turbine machinery. These drain lines are situated at intervals and incorporate a "steam trap" which automatically drains any water that condenses in the lines. Steam traps (Figure 16 & Figure 17) are used on all lines that carry steam throughout the vessel, and often have a bypass line to manually drain a lot of condensate out of the line a bit faster than the steam trap will. Once the line is up to pressure, water cannot exist in the line to any great degree, and the steam traps will handle any that collects in the drain pots. The steam traps are normally connected to a drain line, which transports the condensate to a drain tank where it can be reused. Feedwater and condensate are the "liquid gold" of a steamship, and every effort is made not to waste this valuable commodity.

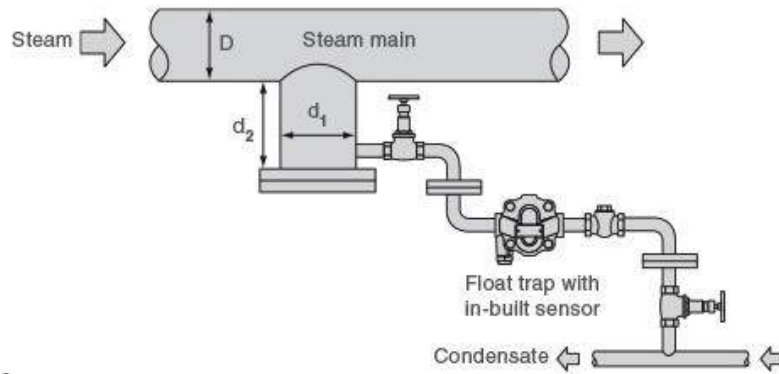

4

Figure 16: Steam trap with connection to drain lines - © Spirax-Sarco

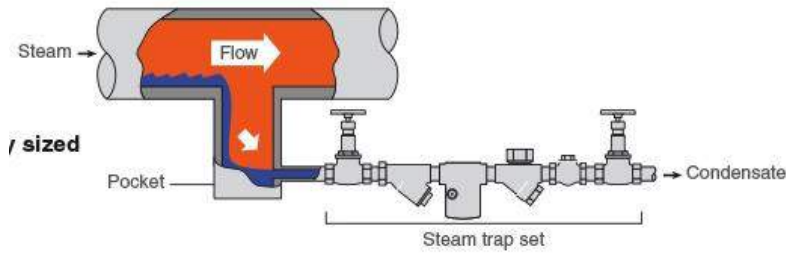

Figure 17: Steam trap in action - © Spirax-Sarco

By this time, the three Scotch boilers are all up to pressure and the fires off until steam is used in the turbo generators. At this stage the superheater starting valve may be closed to avoid wasting steam as there are no hot gases passing through the superheater. IF the boiler is fired, the firemen will open the starting valve again until there is a steam passage through the superheaters.

We now need to get down below to the forward turbo generator room and get things going, but before we do this we need to make sure that the feed system, seawater cooling system and various other systems are up and running such that any steam used is condensed and returned to the boilers.

4 Hotel turbo generator start up

There are three turbo generator sets in the forward turbo generator room, all of which are self-contained in their systems, but with a feed system common to the propulsion feed system, though it operates on its own when using the Scotch boilers in port with the propulsion boilers shut down.

Here's a sectional view through the turbine set, each of which has its own condenser, condensate pumps, LO circulation pump and air ejector –

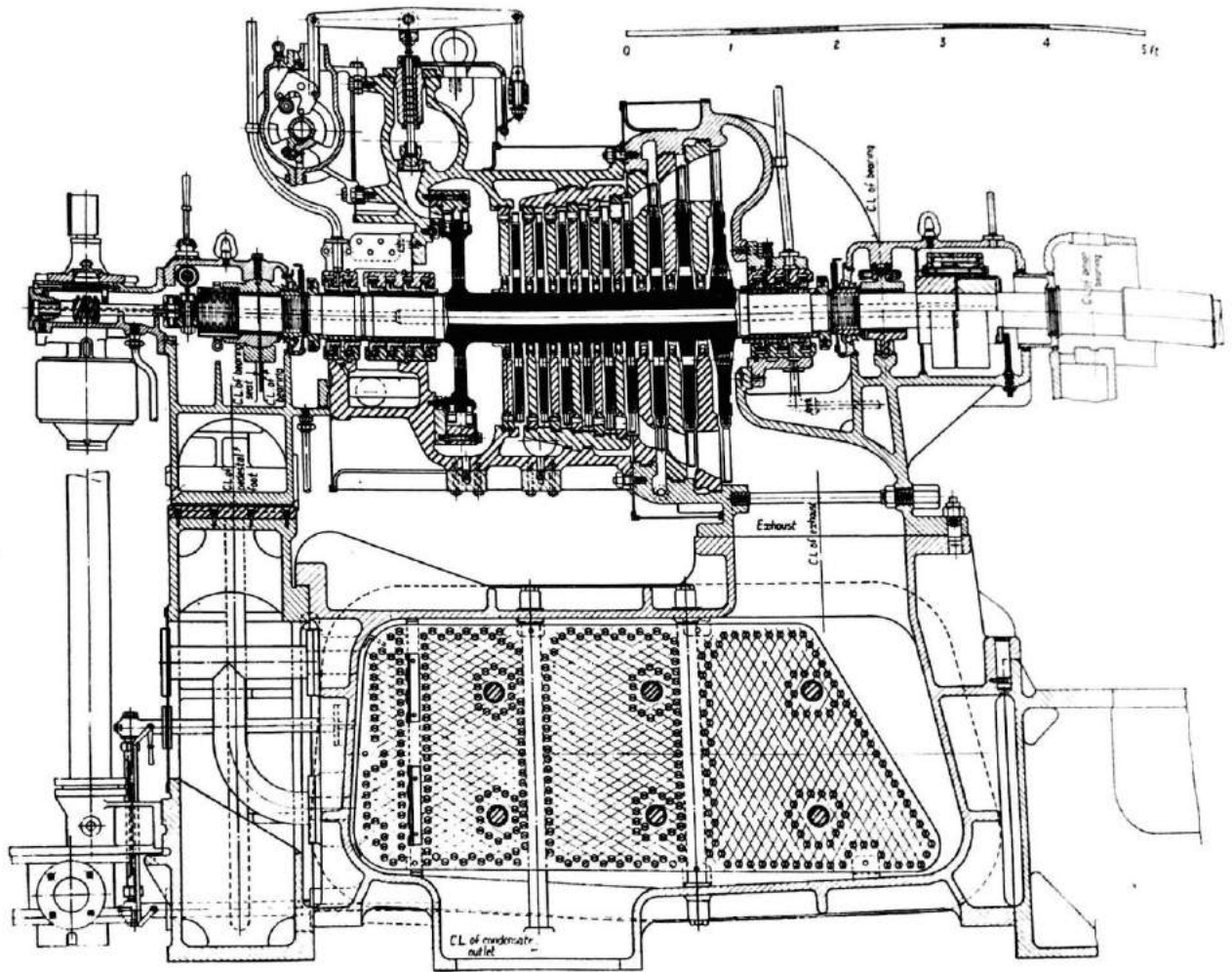

Figure 18 - Sectional view of Turbo Generator

The seven turbo-generators for supplying the whole of the requirement for auxiliary machinery are of the 10 stage type having an impulse wheel and a reaction blading set through which the steam pressure drops as it does work on the blading. The self-contained condenser can be seen in the drawing, meaning the whole machine is mounted as one unit. Each generator provides 1,300kW at 225Vdc, making a combined output of 9,100kW (9.1MWdc). The turbine runs at 5,000rev/min and drives the generator at 600rev/min via a single reduction gearbox. Each set can take steam at 370psi, 680°F, though the hotel sets can take a reduced pressure of 230psi at 650°F

4.1 Before we start – a few basics

There are various services that are required to start a turbine generator, and it's quite a juggling act to get them in the right order. We have a shopping list of items required –

- *Steam* – We have a boiler up to pressure, with light firing every now and then to keep the pressure up with no steam usage as yet. We have both a main full pressure steam line and also a reduced pressure line for smaller auxiliary pumps.
- *Feedwater* – We have a number of small steam pumps which we can use to get water back into the boiler on light usage before starting the turbines. We also have a turbo main feed pump (TMFP), but that's a bit overkill until we get a turbine on the board, as it will be using steam but not really doing anything useful.
- *Seawater* – Once we start using steam, we have to condense it back to condensate and return it to the boiler feed pump as feed water, suitably heated to save on energy. Before we start a turbine, we will use the Auxiliary Condenser, which has a small steam driven seawater circulating pump, plus a steam driven air extraction pump. Condensate from this runs down to the hotwell tank.

Those are the main items we need to get steam from the boiler to the equipment, condense it after use and return it to the boiler. Let's get on with it...

4.2 Starting the TG auxiliary pumps

4.2.1 Auxiliary Seawater Pump and Air Pump

By this time the dry-dock will have been flooded up so we now have seawater all round us. The TG main seawater circulating pumps are quite big at 30-40hp (22kW). Even though we have two emergency generators running (combined 150kW), we have yet to start a few more items, the first one being the Auxiliary Seawater Circulating pump for the Auxiliary Condenser, shown in the plan and elevation of the room below, followed by its air pump – both piston pumps. This will draw a vacuum on the condenser and return the steam from the two pumps back to the hotwell.

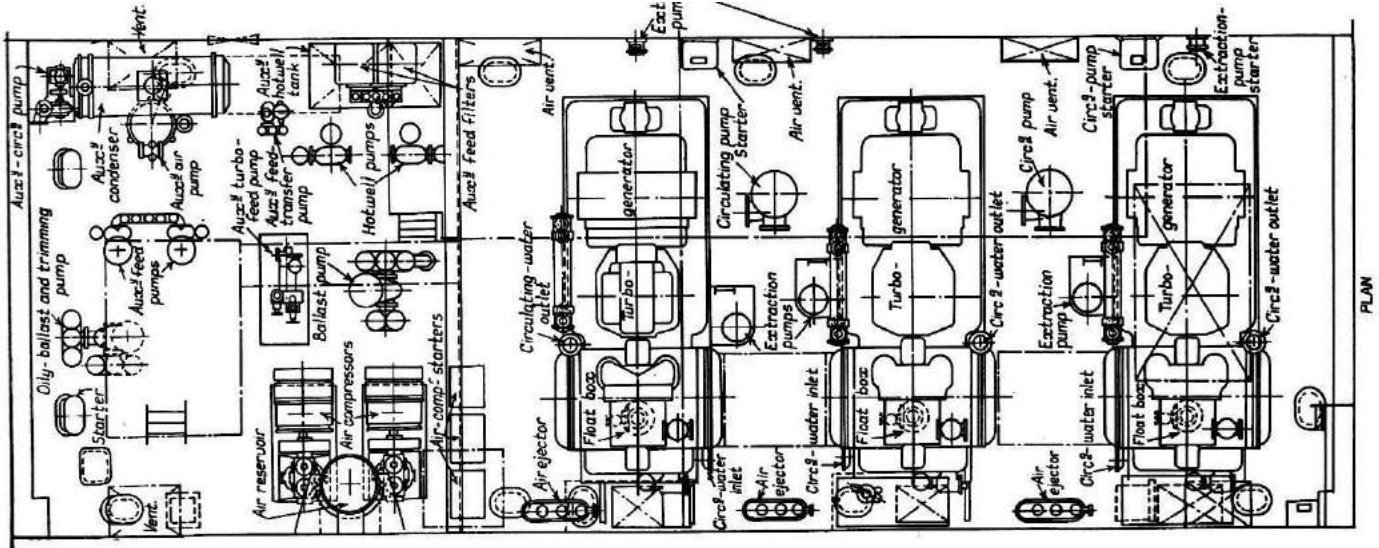

Figure 19 - Forward TG Room Plan

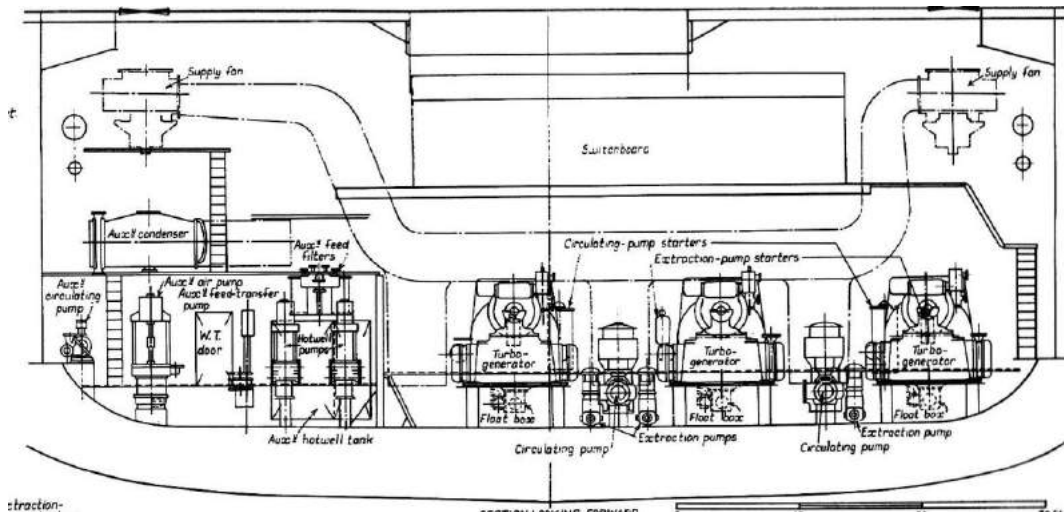

Figure 20 - Forward TG Room - looking forward

In the above two views you can see the auxiliary seawater circulating pump on the port side of the room forward on the bottom level with the condenser above it. Opening up the sea suction valves for this pump, followed by the pump discharge valve, the inlet valve to the Auxiliary condenser, the outlet from the condenser and finally the overboard discharge, will allow us to drain the lines and start the auxiliary seawater pump, which is driven by a vertical steam engine. Seawater passes through the condenser and we check that the pressure gauges before and after the condenser show no appreciable drop on the seawater side. As the condensers have all been cleaned as part of the dry-dock schedule, this is unlikely.

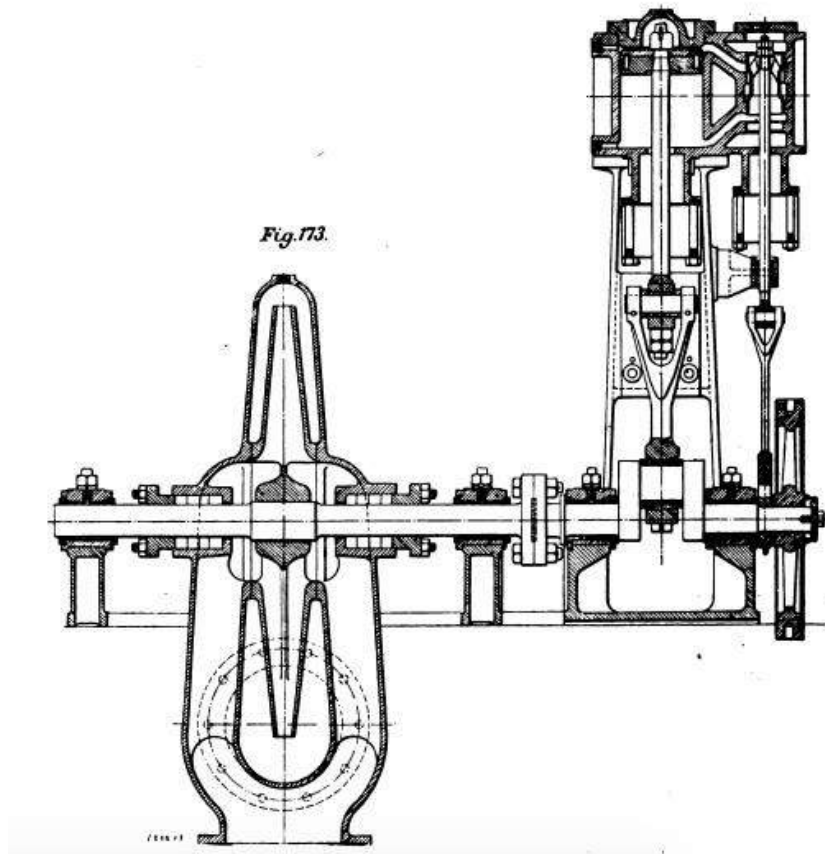

Figure 21 - Auxiliary Condenser Reciprocating Centrifugal Seawater Pump



Figure 22 - Not quite enough water in the dock yet...

4.2.2 DB pump, Makeup Pump, Hotwell and Turbo feed pumps

In the diagram reproduced below (Figure 24 - Closed feed system (auxiliary hotel generators)), these pumps carry out the following duties –

- *Makeup pump* can pump water from the feed water tanks into the auxiliary hotwell tank for use by the rest of the feed system. The auxiliary hotwell tank is the main feedwater usage tank for the Turbo Main Feed Pump. Its exhaust returns via the auxiliary condenser to the hotwell tank

- *Hotwell Pump* discharges to the Direct Contact feed heater, which acts as both a feed heater and deaerator, situated at a height above the TMFP to ensure a positive NPSH (Net Positive Suction Head). Its exhaust returns via the auxiliary condenser to the hotwell tank
- *DB Pump* draws water from the reserve Double Bottom tanks and discharges it to the auxiliary feed water line to the boilers. This is a direct method to fill a boiler with raw water without going through the feed level controller in the main feed line to the boiler. Its exhaust returns via the auxiliary condenser to the hotwell tank
- *Turbo Feed Pump* draws water from the Direct Contact feed heater supplied by the hotwell pumps and heated by bled steam from the TGs once they are running.
-

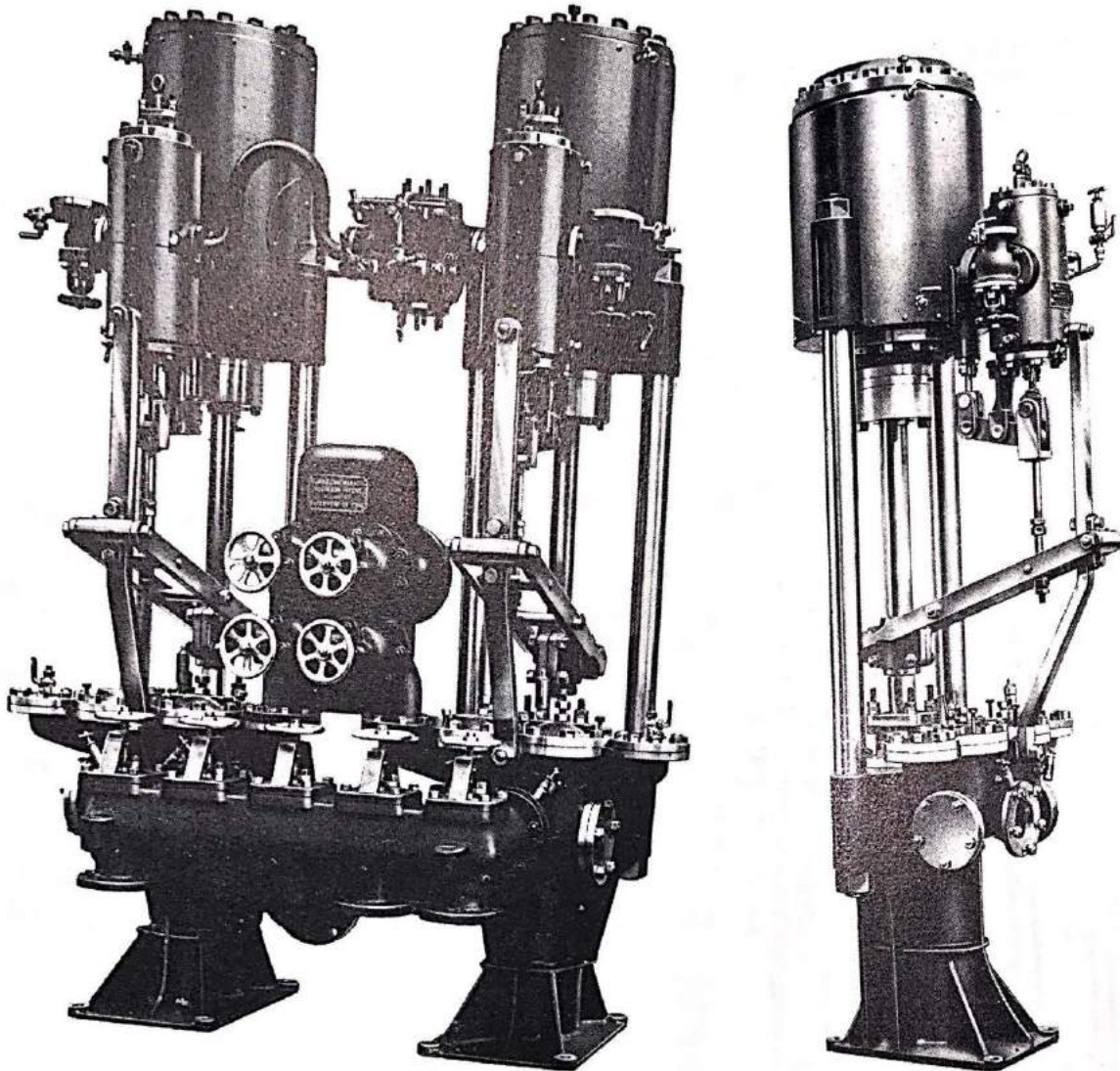

Figure 23 - Duplex and Simplex Double Acting Feed Pumps

4.3 Auxiliary feed system

Below is a schematic to show the line-up of the above pumps and other items in the Feedwater system. It's quite complicated at first, but resolves itself with usage!

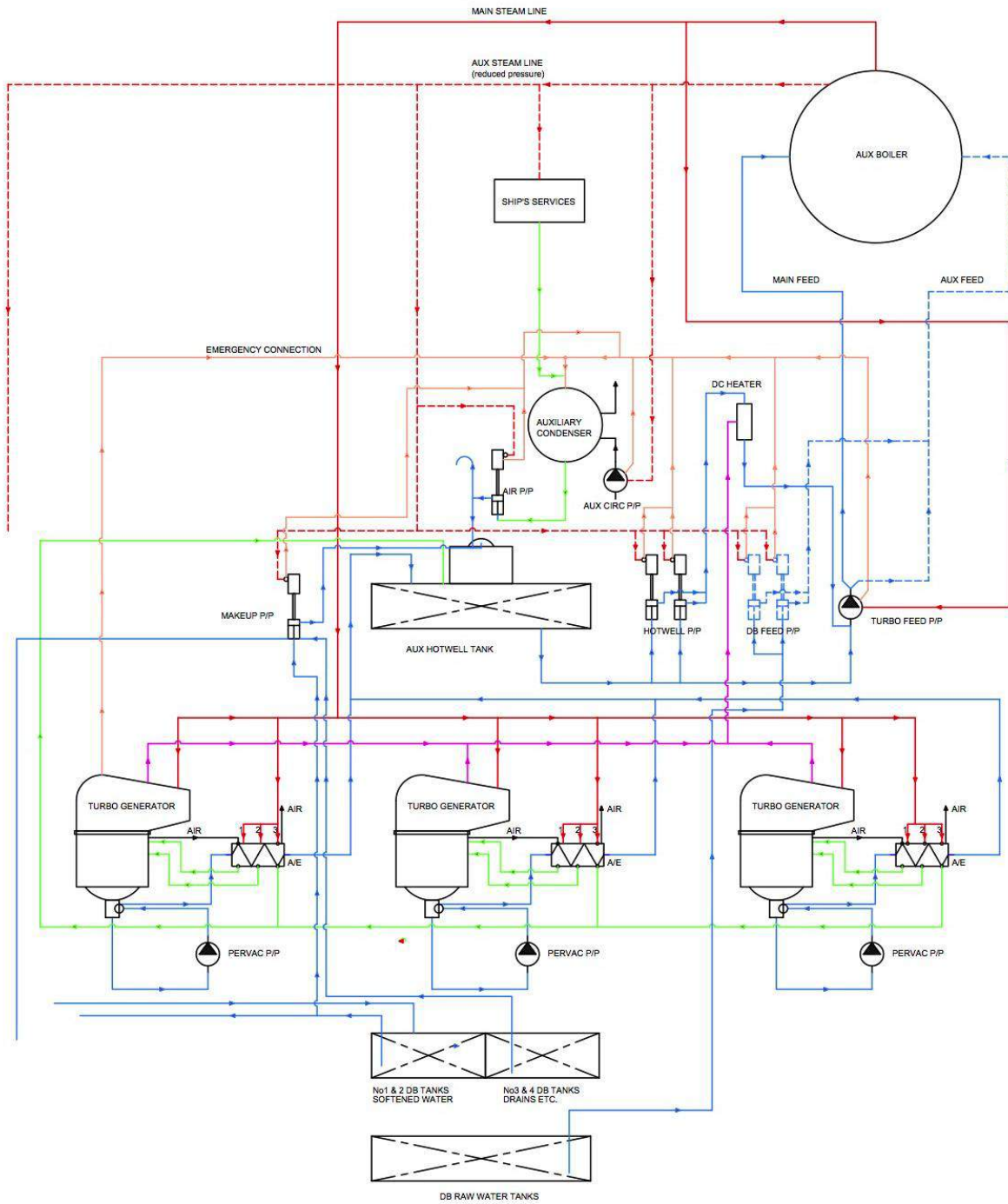

Figure 24 - Closed feed system (auxiliary hotel generators)

We now have a means for getting steam condensed from the pumps and can now go to start up a turbo generator.

4.3.1 TG main seawater circulating pump

This is a large electric motor driven pump, one for each turbine set, which can be seen on the drawings above in Figure 19 - Forward TG Room Plan. We go to the ship's side and open up the main seawater inlet to the condenser suction line, followed by the condenser inlet and outlet valves and finally the condenser overboard discharge. We now have a line from sea to overboard, and can start the pump. The starter is adjacent to the pump, and like most DC starters, it starts on low speed which can be increased using the shunt field regulator, normally a handwheel on the front of the starter.

We'll leave it on slow speed at the moment and check that water is running through the condenser and that there isn't a large pressure drop. This condenser was also cleaned in dry-dock, so we also check for any leaks around the various flanges and vent the air out of the cocks on the seawater boxes.

4.3.1.1 A note on DC faceplate starters

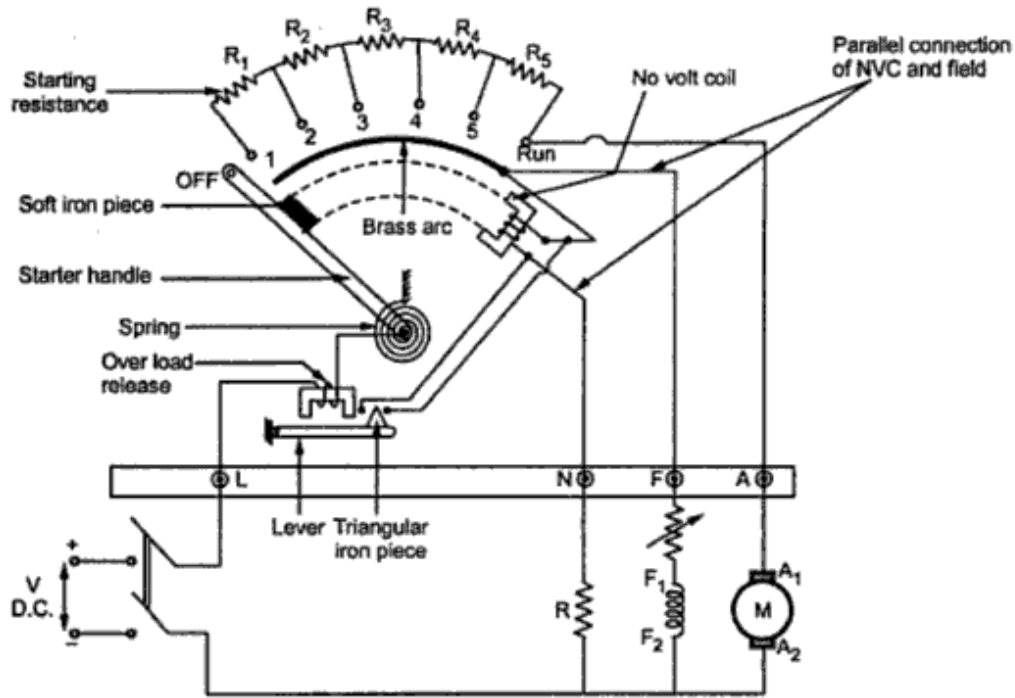

Figure 25 - DC Faceplate Starter

Above is the starter schematic for a typical DC starter. The main parts and their function are –

- *The main breaker* – bottom left with V DC across the + and – terminals. Closing this breaker connects the motor circuit via the overload release to the starter handle
- *The starter handle* – Moving this to position 1 on the series resistance bank connects the circuit via R₁ to R₅ to the commutator of the motor via the brush gear A₁, A₂ and back to the main breaker. The motor starts to turn at slow speed with the full resistance in line and at a low starting current (full direct on current would damage the motor and commutator). At the same time, a circuit is made via the brass arc to the no volt coil, through the resistance R to –ve. Then volt coil energises, as does the shunt field via the variable resistor and the shunt coil F₁, F₂. If the handle is released at this point, the spring will return it to the start position and the starting sequence is aborted.
- As the motor gains speed, the starter handle is gradually moved across the faceplate, removing resistance as it goes, such that the full current is across the motor once all the resistance is shorted out. At this point the starter handle connects with the no volt coil and can be released.
- The motor is now running at its slowest speed with the variable resistor wound to zero resistance such that field flux is increased. If the resistance of the field is now increased by winding the variable resistance in, field flux will decrease. If the field flux of a DC motor is decreased, the motor speed will increase. The amount of resistance in the shunt field circuit therefore governs the speed of the motor.
- In the event of an overload in the motor circuit, the current draw increases the magnetism of the overload release such that it draws the overload lever and triangular piece upwards, thereby shorting out the no-volt coil such that the starter handle is released and returns to the start position under the spring force, thereby stopping the motor.

4.3.2 Condensate Extraction Pumps (Pervac Pumps) and Air Ejector – Port Turbo Generator

The condensate extraction pump – which we will call the Pervac Pump to avoid confusion with all the other pumps - for the port turbine can be seen in the middle of the space, to starboard of the port turbine set that we are going to use. Before we start the pump, we check that there is a level in the condenser, and if not we have to fill it to the right level using water from a make-up tank via the Makeup Pump. Each condenser has a float operated level control valve that maintains the water level in the condenser automatically. Once running and if the condenser level is too low, the Pervac Pump will return water to the condenser from the well until steam starts to condense and raise the well level. Once the level is correct, the controller allows pumping into the auxiliary feed tank from which the Scotch boiler feed pumps draw water to pump to the boilers. If the level is too high, the controller dumps water back to the feed tank. Before starting this pump we have to line it up to the feed system. The Pervac Pump discharges after the controller into the tubes of the TG Air Ejector (A/E), which acts as a feed heater, with the heating medium provided by the steam line from the boiler main steam line. We don't have to drain this line, but can allow it to warm through from the boiler to the feed heater and thence to the TG condenser. As we have the seawater on already, this steam will condense and start to create a vacuum in the condenser. The condenser air ejectors are steam operated, and we can open up the steam to the three stage air ejectors and start to remove air and other non-condensables from the condenser and help to draw the vacuum. The air ejector steam gives up its heat to the feedwater passing through it, with the drains also going to the condenser. As we haven't started the turbine yet, we will just crack this steam on to drain the lines. The Weir 3-stage air ejector is reproduced in the figures below –

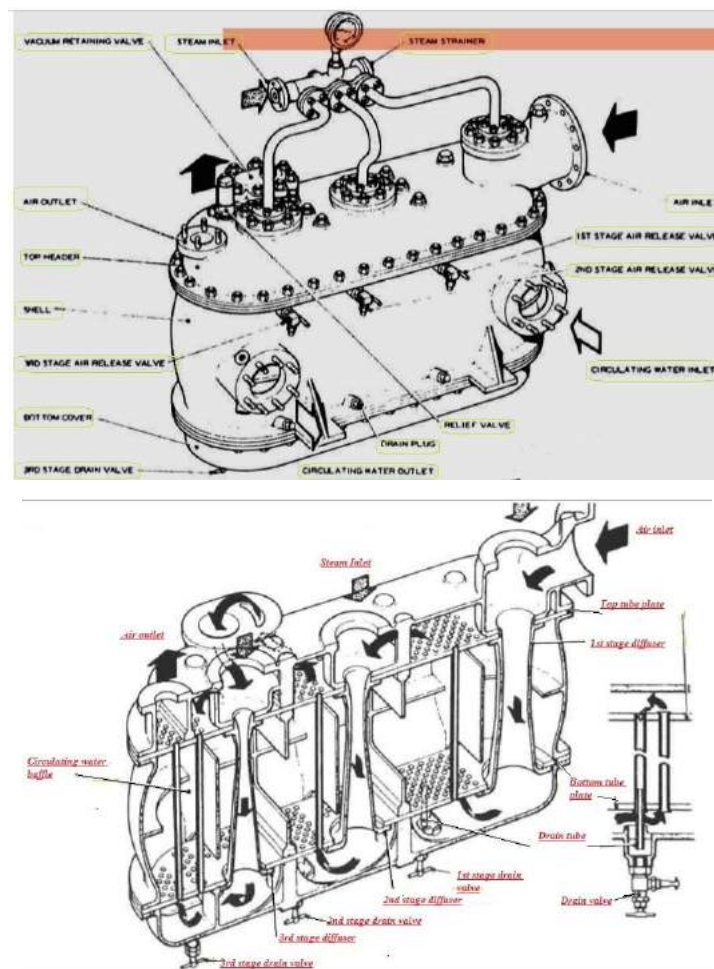

Figure 26 - Weir 3-stage Air Ejector

Steam enters the first ejector and creates a venturi effect of low pressure at the air inlet flange. The velocity of the steam converts to pressure energy through the venturi, with the combined air and steam being lowered in pressure via the diffusers before being drawn via the tube nest into the 2nd ejector and so on to the 3rd stage. The Pervac pump feed discharge passes through the shell from the

1st stage side, and out from the 3rd stage side (upper drawing in Figure 26) passing round the outside of the tubes to both cool the ejectors and at the same time heat the feed passing through it, with the condensed steam returning to the turbine condenser and the air released from the air outlet to atmosphere. In other words, the Air Ejector is a shell and tube heat exchanger with the steam passing through the tubes and the feed water passing through the shell. The feed water returns to the auxiliary feed tank to be drawn off by the auxiliary boiler feed pumps whilst we are starting things up. There is a turbo main feed pump for use on the hotel generator system, but it won't be required until we get the turbine running.

4.3.3 Turbine Lubricating (LO) Pumps

The turbines use the integral LO system to lubricate the bearings on both the turbine, gearbox and the generator itself. An integral LO cooler cooled by the seawater pump cools the oil before returning it to the turbine sump tank. The LO also acts as control oil on the governor of the turbine throttle, such that if the LO pressure drops below a certain limit a Low Level Alarm will sound. Any further drop to the LowLow Level Alarm point will shut the steam off the turbine.

This is an electrically driven pump so we line up the valves on the pump, coolers and turbine, go to the starter and start the pump. For this pump we use the shunt field regulator to run the pump at full speed. The turbine also has an engine driven pump which takes over from the electrically driven one once the turbine runs up to speed, after which the electric pump may be shut down. On modern installations there is a standby function where, if the engine driven pump fails, the electric pump will start up and maintain the supply. This may be fitted to these turbines, though there is no mention of it in the reference work.

4.3.4 The Juggling Act

We are now ready to go and, after draining the steam line right up to the shutdown valve immediately upstream of the throttle valve on the turbine governor, we warm the turbine through by cracking enough steam on via the throttle to pass through the turbine without actually turning it. We will assume that this has been done whilst we've been lining everything else up, and that the turbine is ready to go. Making sure that all the turbine drains are open to the bilge and blowing steam, we change the cocks over to the feed tank rather than waste it. The drains have steam traps on them to automatically drain the casing, so once going they only operate as required.

We open the throttle until the turbine starts to rotate, keeping an eye on the tachometer to make sure it doesn't run away. Once up to around half speed, we test the system by shutting the control oil test valve, which drains the oil off the shutdown valve, which in turn trips the turbine. Resetting the trip, we gradually increase the turbine speed again until the machine is running at full revs, whilst we run around and start to keep all the balls in the air. As we are using a small amount of steam, the turbine exhaust returning and condensing in the turbine condenser will operate on the controller float, causing the Pervac pump to return the condensate to the auxiliary feed tank via the Air Ejector heater. As this has used steam from the boiler, we go across to the TMFP, drain its lines, open the exhaust to the auxiliary condenser, then crack open the steam valve to get the turbine pump going, at the same time as we open the pump discharge up to the main boiler feed line to the boiler via the boiler level controller. As the pump gains speed, water is pumped into the boiler to maintain its level. Our fireman on duty notices that the water level is dropping and checks that the feed controller is open to the main boiler feed checks. At the same time he regulates the flame or lights another burner or two to maintain the steam pressure. As these are double-ended boilers, the fireman on the other furnace side will do the same. They will also warm through on the other two boilers in Boiler Room 1 and commence raising steam.

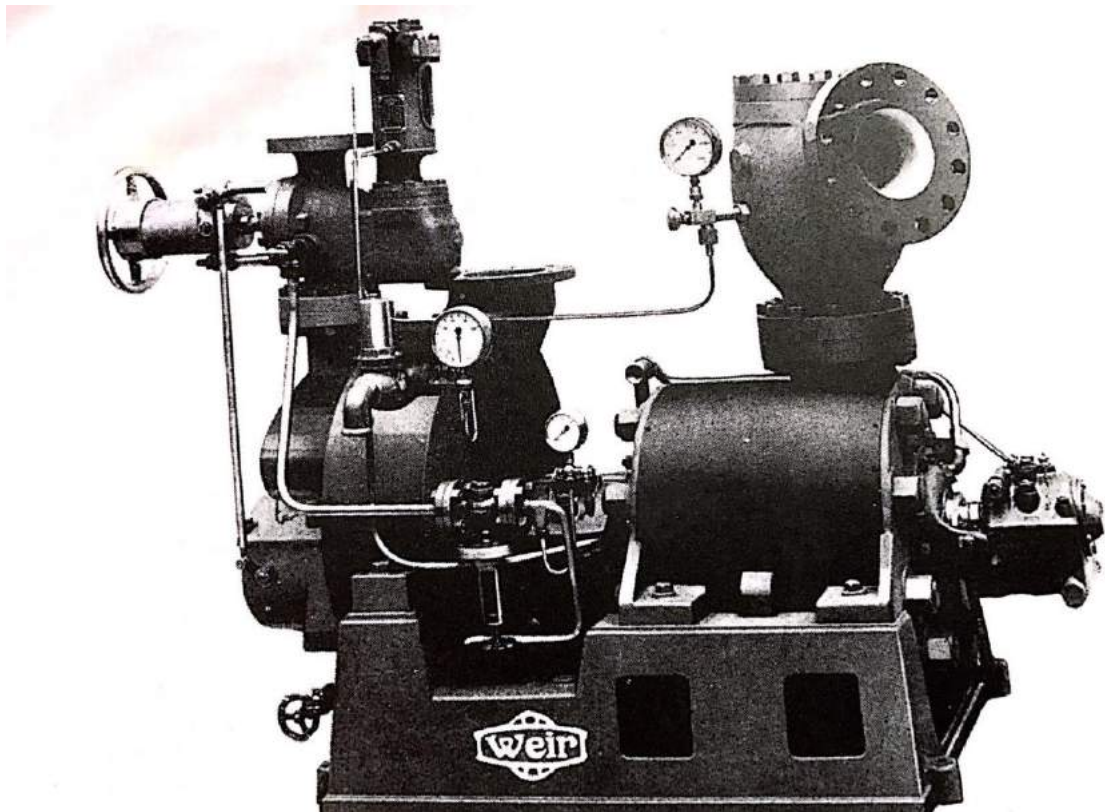

Figure 27 - Weir turbo main feed pump

Back in the turbine room we run up the ladders to the hotel switchboard and close the breaker to put the generator on the board. As we wind up the shunt field regulator, the lights on the voltmeter start to brighten as the voltage rises (no need to synchronise on DC systems) to the full 225V. The switchboard automation at this point drops the emergency generator breakers out, and the emergency load comes on the hotel generator, which starts to use more steam to compensate. We send a Junior Engineer to the Emergency Generator Flat with the Tanky to shut down the generators and top up the fuel tanks with kerosene. A Junior electrician standing by is sent to start the supply and exhaust fans for the TG room, as it's getting a bit warm in here.

One of us standing by the turbine checks the outlet seawater temperature of the turbine condenser, and speeds up the seawater pump if the differential temperature across the condenser is not within bounds (nominally between 7-15°F (4-8°C). For instance if the temperature difference is 20°F, we increase the seawater flow rate via the pump speed until it drops back to normal. When no further drop is noticed, the flow rate can be reduced again until the differential just starts to rise again.

Note: On modern systems a PID controller operating on a thermostatic bypass valve controls the condenser seawater differential temperature. When cold, the seawater is on full bypass. As the condenser seawater outlet temperature starts to warm up, the bypass starts to close allowing more seawater through the condenser. At full power and in warm seawater, the bypass is just about closed, with all the water passing through the condenser – i.e. full cooling.

The feedwater passing through the A/E is now increasing in volume so the steam to the A/E is increased to heat the feed, with the drains going back to the condenser.

We can now heat the feed to the TMFP by taking bled steam off the turbine and feeding it to the Direct Contact heater, at the same time increasing the throughput of the hotwell pumps supplying feedwater to mix with the bled steam and heating the feed passing to the TMFP. As the boiler feed regulator opens, the automatic speed controller on the TMFP reacts to the demand, speeds up and sends more feed to the boiler. As the level rises, the reverse happens – the feed regulator closes in, the pump senses the rise in discharge pressure and regulates the pump throttle valve. We can leave this pump to its own devices now.

This juggling act continues as more load is put on the generator, though once at sea on passage things will quieten down a bit and more or less run themselves once the load settles down.

All our balls are in the air now, and we check each pump and speed it up or slow it down as required – not forgetting the auxiliary seawater pump which is cooling the returns from the auxiliary condenser as the galley, hot water and accommodation heating start to get going.

I think we can treat ourselves to a mug of tea after all that! However, no peace for the wicked as we will soon have to get the other two generators on the board to supply the galleys, heating, hot water, drinking water, lifts, lighting and all the other myriad services needed by the passengers who will soon be arriving on board. Starting the other two generators is the same as starting the first, but we wouldn't start them up unless the load demanded it. The engineers and electricians form a close team in this forward generator room, especially at start up.

As we now have main power, we also have to get the main propulsion systems and feedwater lined up for starting the main propulsion generator sets. These are essentially the same as the hotel sets, but there are four of them to provide power to the engineroom auxiliaries, and they are situated in the after turbo generator room. Before we can get these going though, we have to start up one or more of the water tube boilers. The hotel generators will supply all the power we need for this, so we will head off forward from the forward generator room to Boiler Room 2.

5 Firing a main water tube boiler

Passing through the air lock in the forward bulkhead of the generator room, we enter No 2 Boiler Room, in which there are six boilers of the Yarrow 5-drum type. Before we start, we run up the ladders to the flat above, where the forced draught fans are, and start them up in the usual way. The firemen, boiler room engineers and electricians will look after them once started.

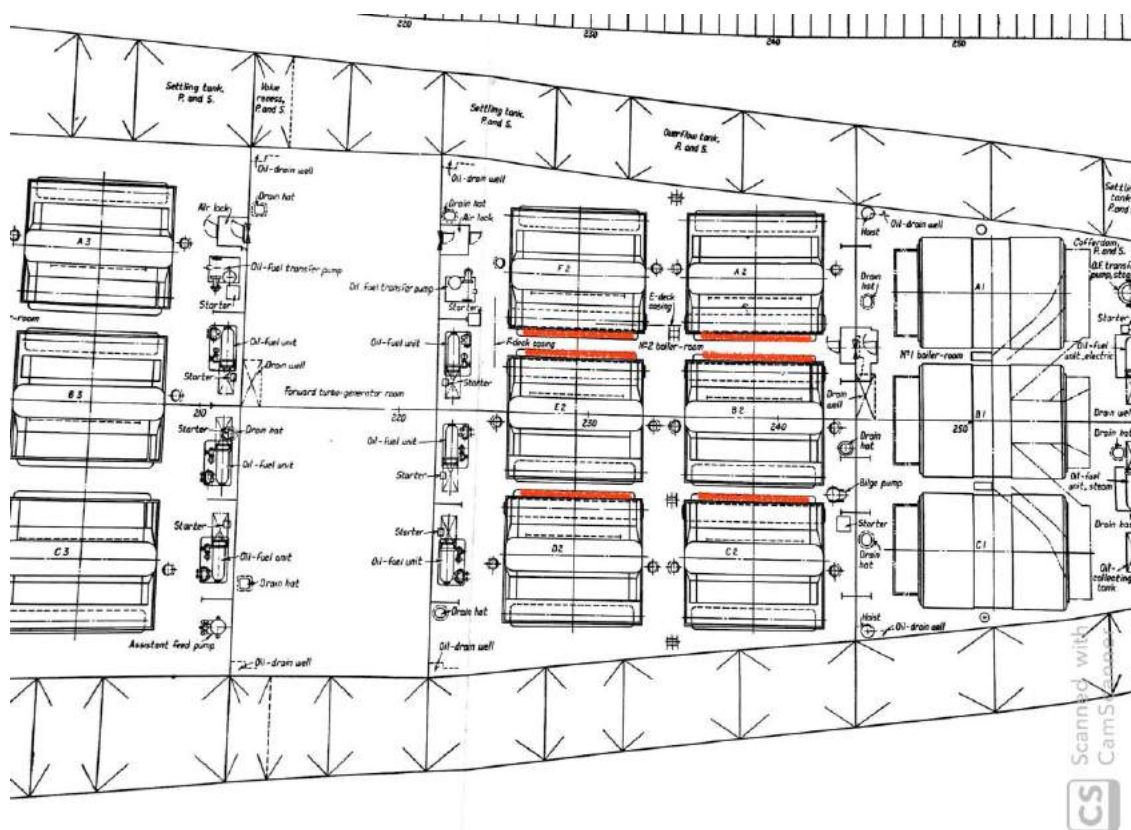

Figure 28 - No 2 Boiler Room Plan

These just about fill the space – the red lines show on which side the side-firing burners are situated. As we exit the air-lock, we see along the after bulkhead the Oil Fuel Transfer Pump and three Oil Fuel

Unit heater sets. All four items of equipment have electric motors, though the heaters are steam driven, unlike the cold-start heater in Boiler Room 1.

Note: Steam is a far more efficient heating medium than electricity as the shell and tube heaters have steam passing through many tubes to give an even heating effect, whereas electric heaters are usually of the immersion type, with at most 3 elements, which takes a long time to warm up and doesn't have much capacity of fuel oil passing through it.

In this boiler room are several firemen all ready to get things going for us. They have used the electric transfer pump to ensure there's plenty of oil in the Settling Tanks and have checked the water levels in the boilers. We do the same, to make sure that there is at least 1" of water in the glass. We go round them all and test them in the same way as we did for the Scotch boilers. As these are high pressure watertube boilers, the gauge glasses are of a more resilient pattern, but are "blown" in the same way. If we need more water in the boilers we can use the auxiliary feed system crossovers, but will assume that all these have a level. If the level is too high, say at the top of the glass, we would have to blow down the boiler until the level shows as both low and high level can damage a boiler.

Note: A low water level (i.e. below the bottom "nut" of the glass) does not give any indication of the level, so the boiler could be dry and firing it could end in disaster. A high water level (i.e. out of the top "nut" of the glass) could mean that the boiler has been "pressed up" to avoid corrosion if laid up for a period. Firing the boiler under these circumstances is effectively a hydraulic test, and as the water starts to expand the boiler could rupture as water is incompressible and the safety valves are designed for passing steam, not water. A 1" level in the glass is just right, as you can see it and it has room to expand as the water warms up under the fires.

The firemen have started the fuel oil pumpsets and cracked the steam on the heaters to start warming through the fuel oil system and have also cracked the steam on the coils in the Settling Tanks ("cracking valves open" means easing them off their seat to allow only a small amount of steam or other fluid through, rather than opening them fully which could – in the case of steam – cause thermal shock to the downstream systems). For these main boilers the settling tank is kept heated to around 30-40°C via steam coils in the tanks. The fuel circulation on these boilers is returned to the pump suction as the circuit warms up (see the drawing for the Scotch boilers), after which the returns are switched to the Settling Tank from which the pumps are drawing. This helps with fuel calculations, as returning the hot oil to a different tank than it is being drawn from will make things difficult to reconcile using the tank gauging system.

Note: The Chief Engineer would not be pleased and you may have to go and see him. On ships as large as this one, that is to be avoided, as it would not be a social call. In fact, avoidance of Senior Officers is usually a good idea for lesser mortals further down the engineering ladder. After the visit to the Chief, you would probably get passed to the Staff Chief who will reinforce the bollocking and hand you on to the Senior Second Engineer who will also tell you your fortune in no uncertain terms as he's the working boss. From him you will be passed down the chain to the engineer officer of your watch; in the boiler rooms, that's probably one of the 4th Engineers, who has already had an "interview" with the Senior Second as to why his Junior (you) hasn't obeyed the instructions! It's called The Chain of Command... Being at sea is a dictatorship, not a democracy. There are around 22 Senior Officers who habituate the Sun Deck accommodation, with a further 92 or so Juniors in the Engineers accommodation on E Deck, making a total of 114. Add to these electricians, firemen and stokers, and there were probably (according to a friend who sailed on her) 150 in the engineering department. (Figure 54)

Here's the obituary of a man who was Chief Engineer on many Cunarders, including the Mary - <http://www.queenmarystory.com/2010/04/from-glasgow-herald-on-this-day-in-1939.html>

With a fire in all six boilers in this room, they will be brought up to pressure and put on line as required as we go round the ship starting other equipment. First we head off to the after turbo generator room to get things going in there. One of the Senior Engineers will take the initiative for firing other boilers in the ship, so we don't have to bother with any more as once again we head aft to

the after turbo generator room. The watchkeepers in the boiler rooms will also look after feed levels and other requirements, using the hotel generators as required until we can start a main generator.

6 Main Turbo Generator start up

The main turbo generator sets are primarily for supplying power to the engineroom auxiliaries. These are many and varied, as we will find out as we start the systems. Here are the plan and elevation views of the space, similar to those of the hotel sets –

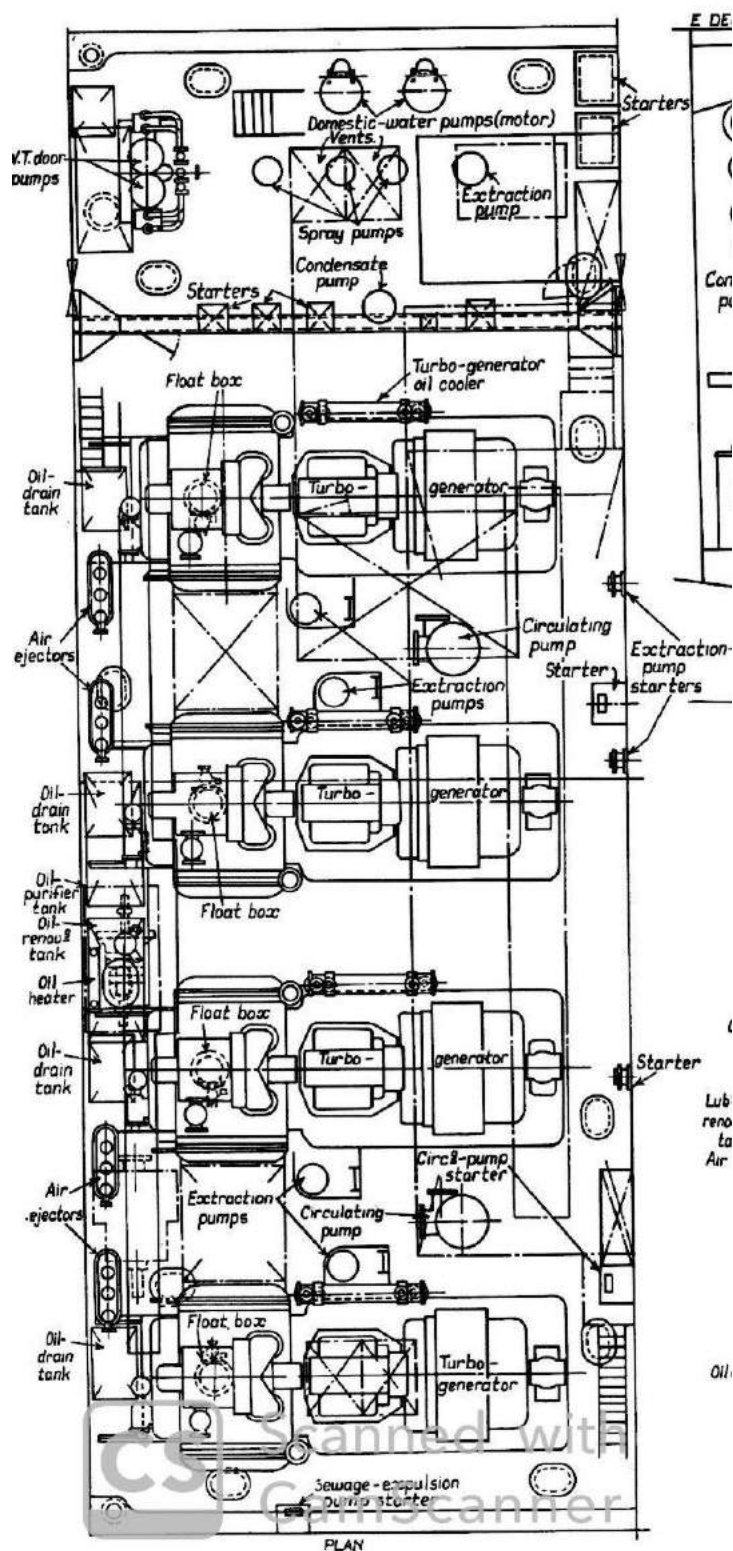

Figure 29 - After Turbo Generator Room

Forward is to the RH side of the drawing, and main machinery in this room comprises –

- The four generators arranged athwartships, with integral condensers
- Two seawater circulating pumps are shown, one for each pair of generators
- One extraction pump for each machine (these are also known as Pervac Pumps, and we will use the term to avoid confusion with other pumps) placed inboard of each pair of machines
- LO circulating pumps (not shown on the drawings), LO tanks and centrifugal purifier
- Air ejectors, one for each machine, mounted on the after bulkead

6.1 The Main Generator steam, feed and condensate system

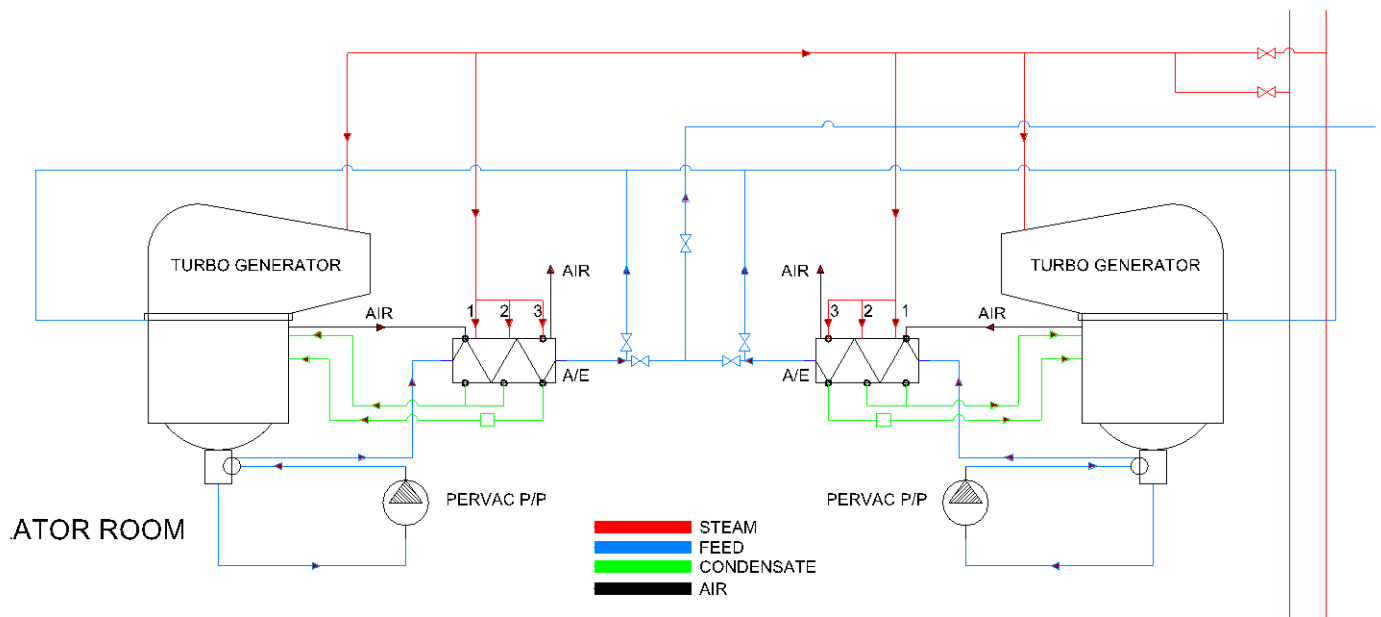

Figure 30 - Main generator turbine steam and feed schematic

Above is a schematic from the ship's main feed system diagram. The main points of interest are –

- *Main Steam* – is fed to the throttle governors of the 4 turbines
- *Condensed Steam* – is drawn from the bottom well of the condenser and returned to the feed tank. This can also be directed to the other turbine condenser as make-up feed. Other means of make-up from the feed tank are not shown for clarity
- *Pervac Pump* – otherwise known as the condensate extraction pump, draws from the condenser well and discharges through the Air Ejector feed heater
- *Air Ejector* – Uses steam ejectors to draw air and other non-condensables from the condenser and releases them to atmosphere. The heating effect of the 3-stage steam ejectors serves as a feed heater. *Note: Whilst the drawing shows the feedwater passing through the tubes, this is not the case (it's taken from the ship's original drawings), as it's the steam that passes through the tubes, and the feed water through the shell) – refer to Figure 26*
- *Feed tank* – the feedwater after passing through the air ejector returns to the main feed tank supplying both generators and main engine feed systems

6.2 Starting the seawater circulating pumps

Each pair of turbine condensers are served with seawater via the seawater circulating pumps. These are a fair size, and we start by opening up the seawater induction valves, inlet and outlet valves on the condenser, and the overboard discharge.

The starters for these pumps are shown in Figure 29 - After Turbo Generator Room, mounted on the forward bulkhead. As with other pumps, we start these in the same way, on slow speed to protect the

motor from damage (See starter notes at Figure 25 - DC Faceplate Starter). Once started we note the inlet and outlet pressures of the condensers to ensure that there is no appreciable pressure drop. This would occur with fouled tubes, but these condensers have been cleaned in dry-dock so we expect the differential pressure to be normal. At this stage the inlet and outlet temperature gauges should show the temperature of the seawater in the harbour. At this time of the year – September – this would be around 63°F (17°C) – a bit chilly if you fell in...

We carry out the same procedure with the other seawater-circulating pump for the port pair of turbines.

6.3 Pervac condensate extraction pumps

Firstly, we check for a water level in the condenser well. If there is a level showing, we are OK to start the pumps, as the level controller will keep the level automatically. If the level is too low, we can use the make-up system (not shown on the diagram) to fill to a reasonable level. The starters for these pumps, one for each turbine condenser, mounted inboard of each pair are also mounted on the forward bulkhead. Opening the pump suction and discharge valves, and any other valves in the feed system, not forgetting the return to the feed tank, we can start the pump in the usual way. For these pumps we can wind them up to full speed as there is no need for speed control with the level being automatically adjusted by the condenser water level controller. If the condenser level is too high, the controller will dump back to the feed tank. If too low, it will cause the Pervac pump draw from the feed tank to return water to the condenser until condensing steam restores the level. With the level correct, the Pervac pump will circulate from the condenser well back to the condenser steam space until the condenser level rises.

6.4 Starting the Air Ejectors

The 3-stage air ejectors can now have the steam cracked on to the nozzles within the ejector body (see Figure 26 - Weir 3-stage Air Ejector). This will start to evacuate air from the condenser and help to draw a partial (about 20") vacuum, though the main vacuum will occur once the exhaust steam from the turbine enters the condenser. Whilst we can draw a vacuum with these ejectors with no steam passing through the turbine, it needs the condensing steam to maintain the vacuum once the turbine is running on load. Too high a vacuum on start-up is not good for the turbine rotors either. We make sure via the drains that water is being returned to the condenser from the A/E and not steam, by adjusting the steam inlet valve, as there is no feed flow through the ejector at present.

6.5 Starting the turbine LO pumps

There is an electric motor driven LO pump for each turbine (not shown on the plan). Opening up the valves in the system in the same way as we did for the hotel turbines, we can start the pumps. As with the Pervac pumps, these LO pumps run at constant full speed. Once the turbine is up to speed, the engine-driven LO pump will maintain the pressure in the system and lubricate all the bearings. If this pump fails, the electric pump should start automatically. In installations where this is not the case, a header tank is supplied to ensure enough oil to the bearings on turbine trip.

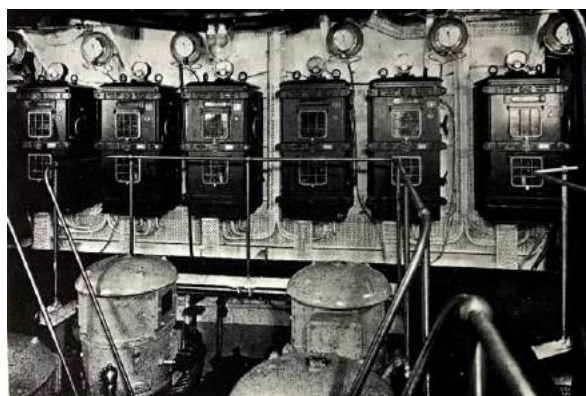

Figure 31 - LO pump starters and pumps

6.6 Starting the turbine

We are now ready to start in the same way as the hotel sets, though in this case other engineers in the enginerooms are looking after the feed system and boilers so our job is a bit easier. After draining the steam line right up to the shutdown valve immediately upstream of the throttle valve on the turbine governor, we warm the turbine through by cracking enough steam on via the throttle to pass through the turbine without actually turning it. We will assume that this has been done whilst we've been lining everything else up, and that the turbine is ready to go. Making sure that all the turbine drains are open to the bilge and blowing steam, we change the cocks over to the feed tank rather than waste it. The drains have steam traps on them to automatically drain the casing, so once going they only operate as required.

We open the throttle until the turbine starts to rotate, keeping an eye on the tachometer to make sure it doesn't run away. Once up to around half speed, we test the throttle trip by shutting the control oil test valve, which drains the oil off the shutdown valve, which in turn trips the turbine. Resetting the trip, we gradually increase the turbine speed again until the machine is running at full revs, whilst we check round the condenser seawater and LO system temperatures and pressures. As we are using a small amount of steam, the turbine exhaust returning and condensing in the turbine condenser will operate on the controller float, causing the Pervac pump to return the condensate to the main feed tank via the Air Ejector heater. As this has used steam from the boiler, engineers in Boiler Room 2 will look after the steam pressure, temperature and water levels.

Once we are satisfied with everything, we go up the ladder to the main switchboard and close the generator breaker for this machine onto the board. Winding up the shunt field resistance, the generator starts to feed the systems in conjunction with the hotel sets. Once we have three of the machines running (one is a redundant unit), the electricians will switch the various circuits around such that the hotel and main switchboards are independent from each other. This will relieve the hotel load as there are some large motors that will be started for the remaining boilers and propulsion turbines. We check again that the seawater pumps are supplying sufficient seawater to keep the differential temperature across the condensers within limits and pass over the aft turbo generator room watch to the oncoming watchkeepers. Time for another cup of tea and leave the machinery spaces to see if the galley has anything to eat... We are not back on watch for 8 hours, so have plenty of time whilst the propulsion boilers are brought up to pressure.

7 The Main Propulsion Feed System

We are back down below again for our next watch, and this is an ideal time to get stuck into the main feed system. As with the other feed systems for the generators, this is a "closed feed system" meaning that air is excluded from the system with no atmospheric tanks to allow its ingress. That's the theory, though more modern systems are far more effective than these early ones.

7.1 The feedwater heaters

The feedwater heaters are arranged in series in the feed line from the condenser to the boilers. Their purpose is to heat the feedwater to the boilers, and this is achieved by passing as much exhaust and "waste" steam as possible from auxiliaries through them in order to extract the last vestiges of heat from the steam. To augment the exhaust, bled steam from the turbines is also used.

These heaters are the -

Air ejectors – There are two of these arranged in parallel for each main turbine set. They are similar though larger than the 3-stage ones for the generators. Live steam from the main steam line heats the feedwater passing through them from the Pervac Pumps. The steam passes through the tubes, whilst the feed passes round them through the shell. The steam condition into the air ejector is at 250psi, 650°F.

Drains Coolers – This is the second feed heater in the feed pump suction line, the heating medium of which consists of the combined drains from one LP feed heater (next in line) passing through the heater and returning to the condenser. The unit is capable of raising the feed water temperature from 84 to 115°F, with the heater drains being cooled to 95°F before passing to the main condenser. The drains coolers are arranged four-flow on the water side.

Low Pressure heaters – There are four of these, one for each turbine set. They are designed to raise the temperature of the feedwater from 115°F to 205°F. These heaters take their steam partly as vapour from the evaporators, the exhaust steam from the turbo-feed pumps and part steam bled from the main turbines.. In addition, the combined drains from one intermediate pressure heater and the coil drains from the evaporators are led to the LP heaters. These heaters are 6-flow on the water side and are fitted on the suction side of the TMFP.

Intermediate Pressure feed heaters – These are situated on the discharge side of the TMFP and are designed to raise the feedwater temperature from 205°F to 320°F. The heating medium comprises steam bled from the main turbines at a pressure of 150psia and 160°F superheat, with in addition the drains from one HP heater. These heaters are 6-flow on the water side.

High Pressure feed heaters - The final stage of feed heating takes place in the four HP heaters, one per engine set. These are designed to raise the feedwater temperature from 320°F to 370°F. The heating medium comprises steam bled from the main turbine at a pressure of 230psia and 230°F superheat.

7.2 Turbo Main Feed Pumps

There are 8 Weir turbine-driven two-stage feedwater pumps, 4 working and 4 standby. These are capable of discharging at 500psi with a steam supply of 400psi and 700°F, exhausting against a backpressure of 22.5psi. The exhaust steam is discharged via the LP heater and Drains Cooler to the hotwell or the condenser shell by a 3-way valve. The pump delivery is controlled by a pressure operated governor on the turbine throttle valve, in conjunction with the operation of the boiler water level regulator.

7.3 Condenser level controllers

Each condenser is fitted with a Weir feed water level controller. Should the level in the condenser fall below the set point, the level controller will cause water to be drawn by the Pervac pumps from the hotwell to raise the level. Conversely, if the level should rise, the controller will dump water back to the hotwell/feed tank as required until the level set point is again satisfied.

7.4 Boiler feed water regulators

To avoid overfilling (or under filling) the boilers, their level is maintained with an automatic feed water regulator. The feed regulator mounted near the boiler is governed by the level in the boiler and, should the level fall, the regulator will open to the boiler, causing a drop in the feed pump discharge pressure which will in turn increase the flow of steam to, and therefore the speed, of the pump. Once the boiler level is satisfied, the controller shuts off the inlet to the boiler, the discharge pressure on the feed pump increases, and the steam valve closes in, slowing the pump. In this way, the stokehold crew controls the level automatically, with only routine checking of the levels, compared with manual control where the valves had to be operated manually and almost continuously. Leak off from these regulators returns to the hotwell.

7.5 Hotwells and feedwater tanks

These tanks are essentially the same thing. The after engine room has two 14t hotwell tanks, one port, the other starboard against the forward bulkhead, whereas the forward engine room has a single 28t tank situated on the centreline on the forward engine room forward bulkhead, underneath the feed heaters.

7.6 Assistant DA feed pumps

There are two Double Acting piston feed pumps used for feed duties such as makeup, transfer and starting, which are shown on the engineroom plans included in the machinery section. The boiler room engineers will have used these small pumps as feed to the watertube boilers when raising steam and under low steam consumption periods as they are of lower capacity than the turbo pumps and use less high pressure, high temperature steam, being fed from the Scotch boilers we started up earlier, with their exhaust steam returning to the Auxiliary Condenser.

8 Main engine auxiliaries

As we now have both ample steam and power, we can get going on starting up the main engine auxiliaries. These comprise (referring to the drawings below) –

- *The main seawater pumps.* There are 2 of these for each condenser, so 8 in all. In the after engine room they are positioned outboard aft of the condensers, and in the forward engine room they are placed either side of midships aft. Each pump is rated at 285hp (213kW) of 25,000gpm flow rate (6819m³/hr), so 50,000gpm (13,638m³/hr). These pumps are arranged as 2x50% units, meaning that both are running when the turbine is at full power.
- *The Main condensate extraction pumps.* There are two of these for each condenser, 8 in all, and working on a 2x100% redundancy such that either can provide the full extraction of feedwater from the condenser. In the after engine room they are placed forward of the condensers on either side, and in the forward engine room they are placed under the condensers. Each is capable of a flow rate of 550,000lb/hr (250m³/hr) of condensate, driven by a 55hp (41kW) electric motor.
- *The main engine lubricating oil (LO) pumps.* There are 3 of these per engine set, arranged as 3x50% units, such that two are running at any one time to supply the turbine bearings and the gearbox with oil.
- *The Main Engine lubricating oil coolers.* There are 4 of these per engine room, which are circulated with seawater to cool the oil exiting from the bearings before returning it to the turbine and gearbox sumps
- *The Oil Cooler circulating pump.* This is a small seawater pump that supplies the seawater cooling to the coolers above. There is one of these per cooler set (2 per engine room)

The above equipment, along with the feed system can be seen in the following diagram.

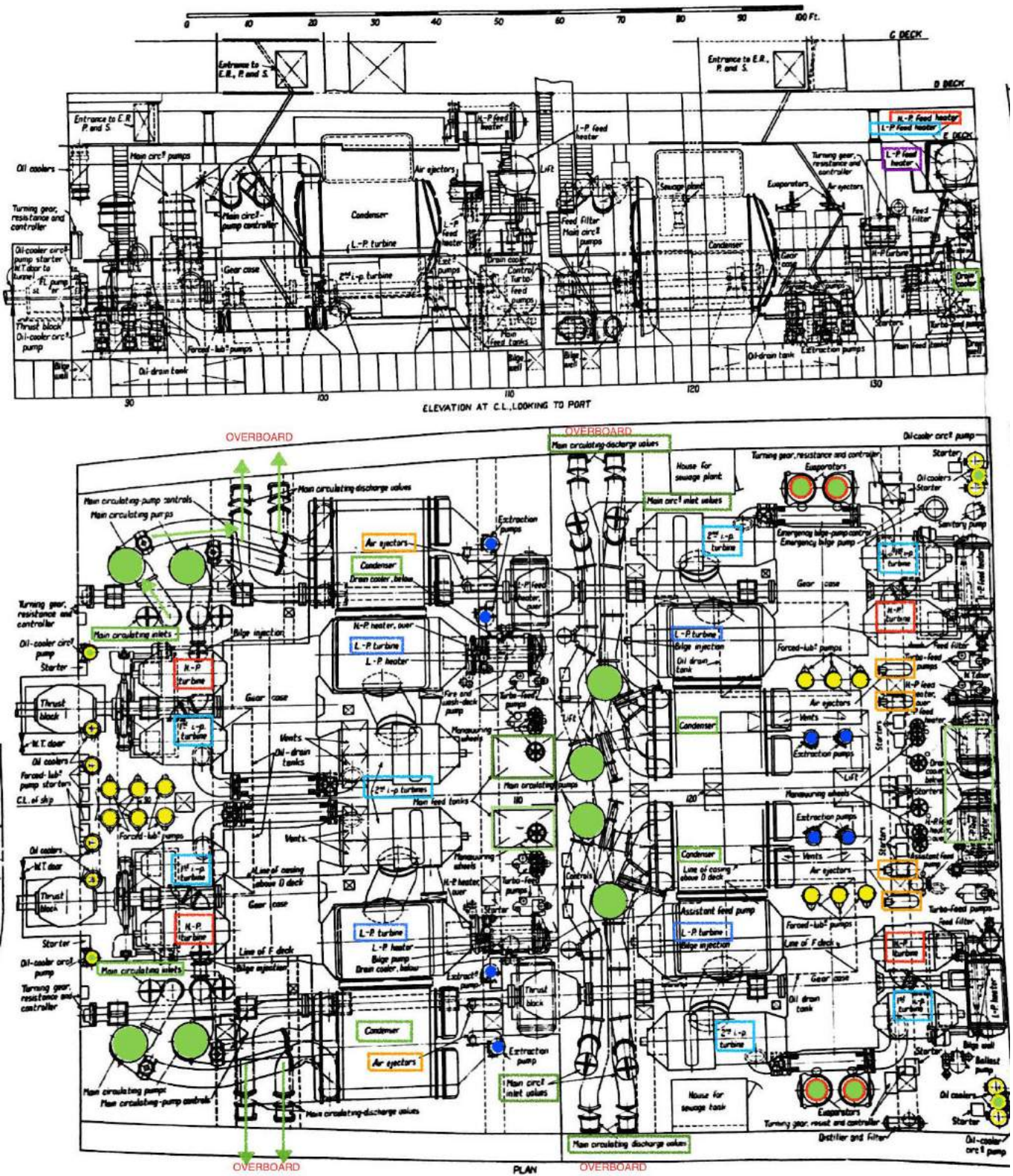

Figure 32 - Plan and elevation of engineersrooms

In the coloured drawing above you can see the following equipment:

- *Main seawater pumps* – Green (solid) with their seawater induction and discharge pipes and valves
- *Condensers* – Green notation box
- *LO pumps* – Yellow (solid)
- *LO coolers* – Yellow ring
- *LO Cooler seawater circulation pumps* – Yellow ring filled with green
- *Pervac Extraction Pumps* – Blue (solid)
- *HP turbines* – Red box
- *IP turbines* – Cyan box
- *LP turbines* – Light blue box
- *Air ejectors* – Orange box
- *The HP, IP and LP Feed heaters* – Red, Light Blue and magenta (elevation drawing)
- *Evaporators* – Red circle filled with green
- *The Feedwater tanks* – Light green border
- *The engineer's Lift* – The one we used to go up to start the emergency generators; can you find it?

In the following coloured sectional drawings you can see how the equipment is arranged in the enginerooms by looking forward and aft from various points (defined by the Frame No) within the space.

Starting from the after end of the after engineroom and looking forward –

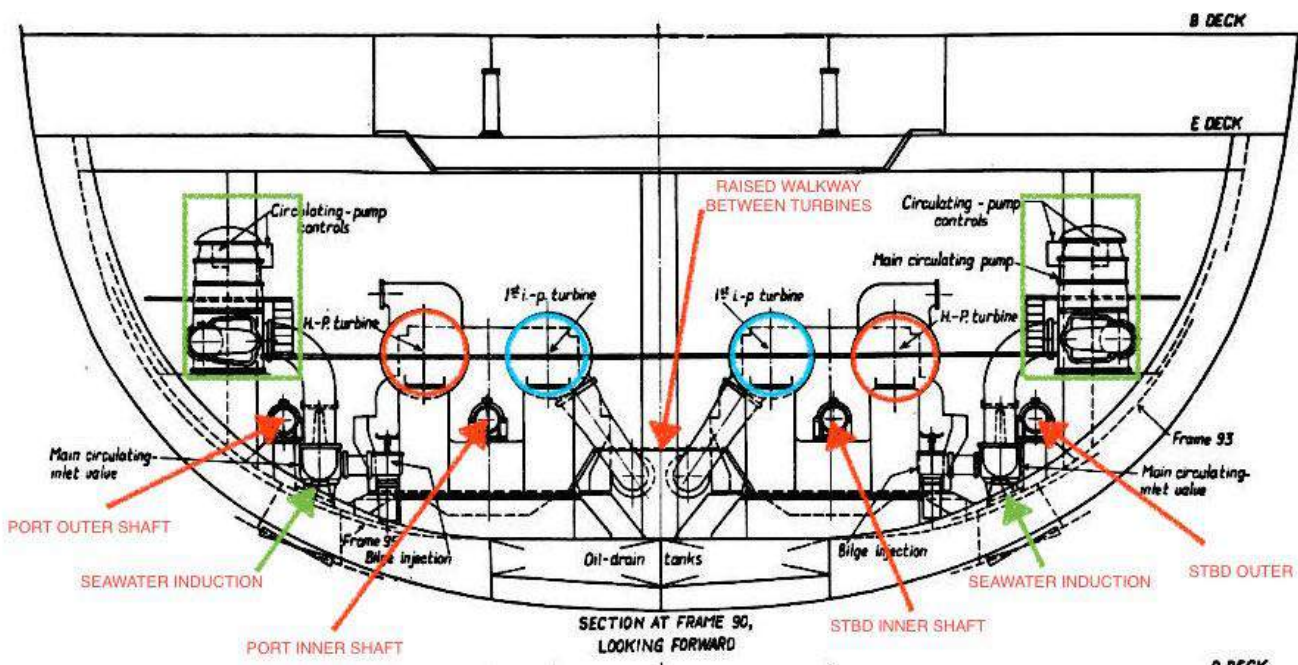

Figure 33 - Section at Fr 90, looking forward

Here we are looking forward; ready to walk between the turbines. We can see the HP and 1st IP turbine sets (red and cyan), the two (actually four, the other two are behind) massive seawater pumps outboard of the outer shafts (which are coming through the bulkhead from the forward engineroom). Under the bottom are the seawater induction grids that feed seawater into the circulating pumps via the sea suction valves, which we will now open before starting the SW Circ pumps.

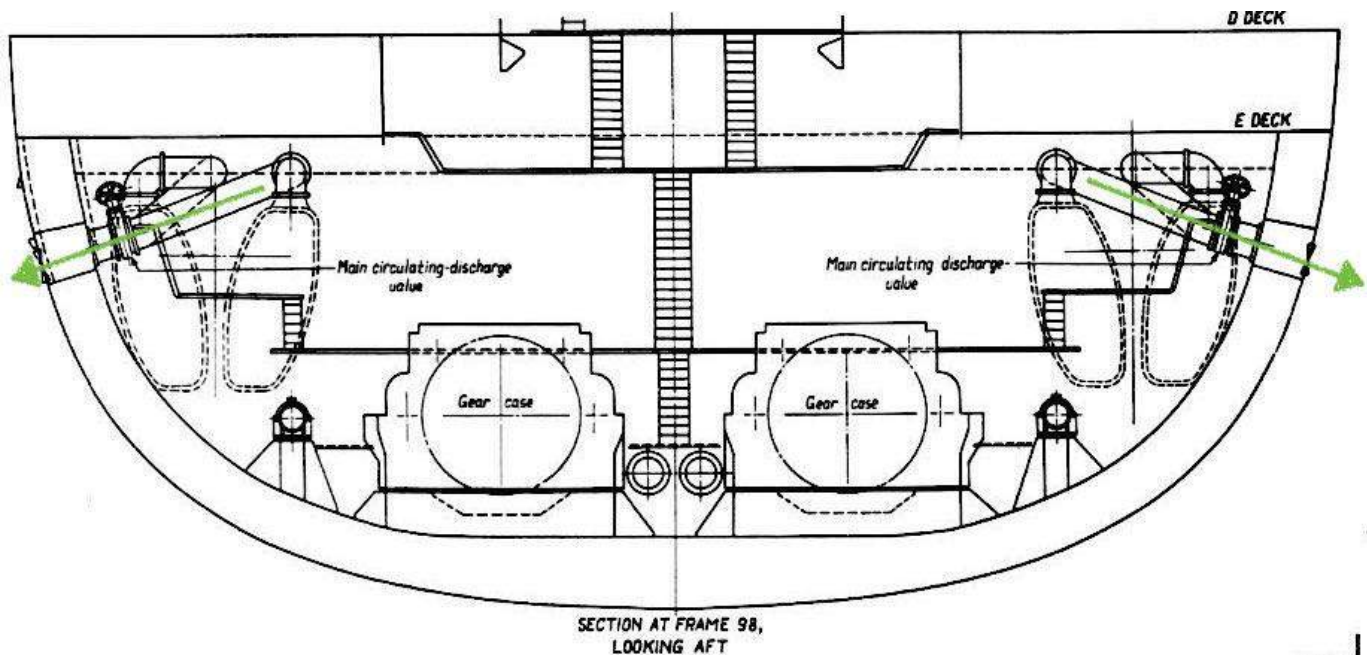

Figure 34 – FR 98 Looking aft

8.1 Main seawater pumps and valves

Above we have walked forward a few frames, and are looking aft, where we can see the two condensers outboard, the two gear cases for the port and starboard turbine sets, and the overboard valves for the condensers. These are the discharges in the side of steamships that show a large volume of water going overboard (green arrows). You can also see the ladders going to the decks above the engines. You can climb up the ladders to the outboard overboard valves and open them up, along with the valves into and out of the condensers, after which I'll open the seawater inlet valves (Figure 34 – FR 98 Looking aft) and start the pumps. These pumps are pretty huge, and we take the precaution ex dry-dock to vent the casings of trapped air to avoid the pump running dry. Once that's done, we do the usual with the starter and wind the pumps up to normal speed – one port and one starboard (there are four, the other two are on standby in case of failure of the running set). We check round up and down the levels to make sure that the dockyard has not left us with any seawater leaks.

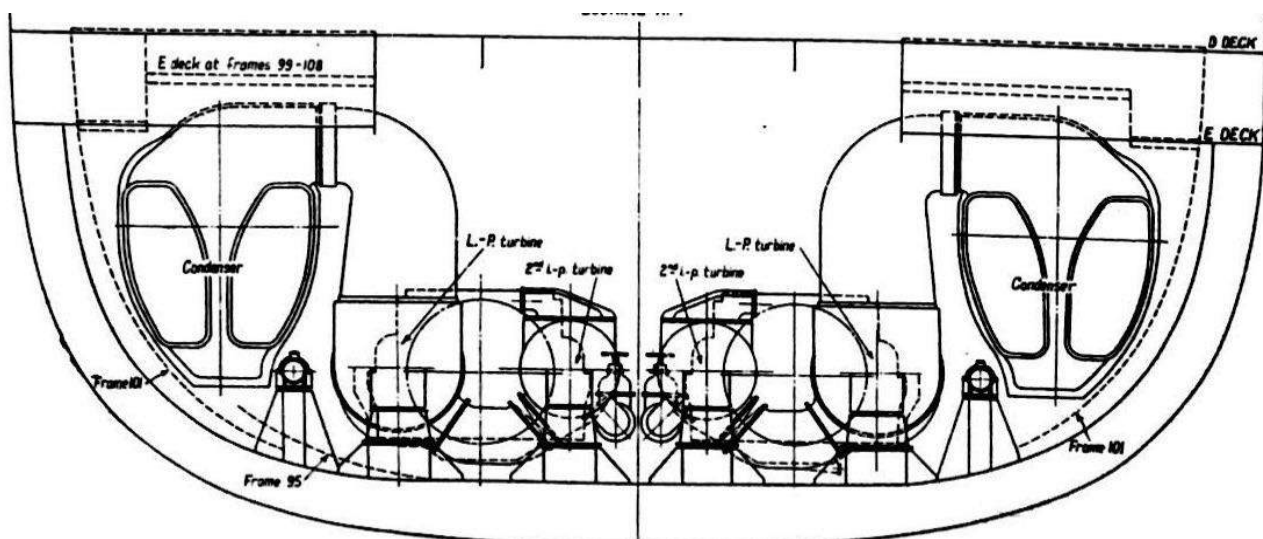

Figure 35 – Fr 108 Looking aft

A bit further through the after engine room, and on looking aft we can see the large exhaust bends that discharge into the condensers port and starboard.

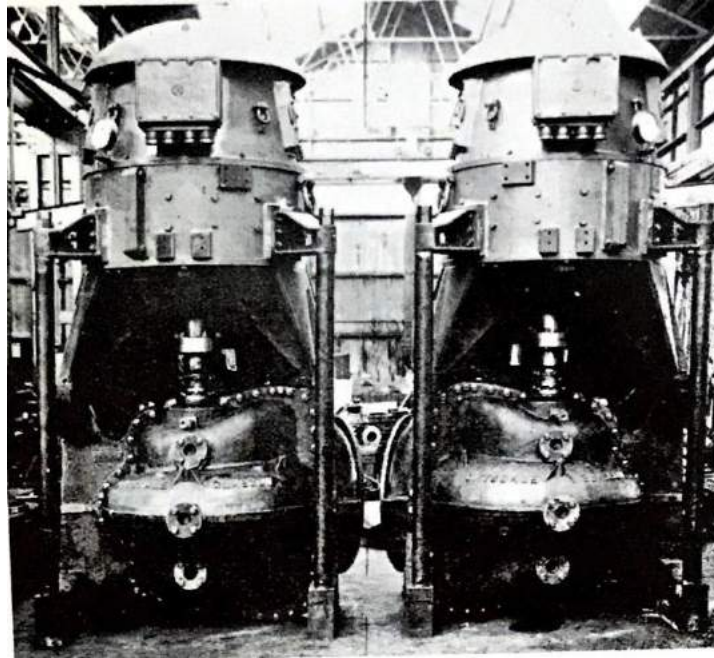

Figure 36 - A pair of main seawater pumps in the workshop

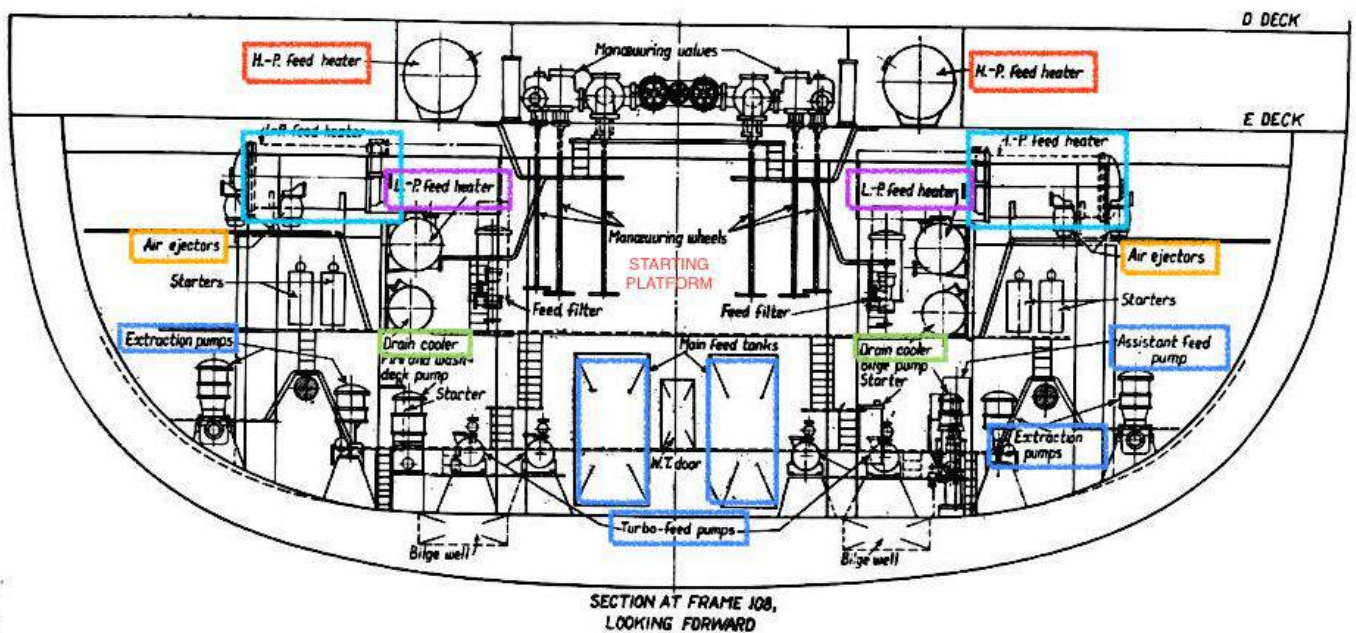

Figure 37 - Fr 108 Looking forward

From the same frame we see a lot more of the equipment in the after engine room when we turn round and look forward. We are looking at the forward engine room bulkhead, towards the Starting Platform, which is still viewable on the ship in Long Beach, though unfortunately everything forward of the bulkhead has gone. In our case though it hasn't, and we will be going through that watertight door later.

In view are the three feed heaters for each turbine set, mounted on the forward bulkhead area. The LP feed heaters are mounted higher than the feed pumps in order to give a good NPSH (Net Positive Suction Head) to the feed pumps (shown in blue under the bottom plates). These LP heaters are therefore mounted on the suction side of the feed pumps, which latter discharge through the IP and HP heaters to the feedwater main. The air ejectors, DA Assistant feed pump and the Pervac extraction pumps are also to be seen. We have a lot to do here, so will line up the feedwater system and get some pumps going, some of which are on the engine room plan earlier (Figure 32 - Plan and elevation of engine rooms).

8.2 Air ejectors

Now that the seawater pumps are running, we can leave the bottom plates go up the ladders on either side and start the air ejectors to draw a vacuum on the condensers of around 20". When warming through the turbines it's not prudent to pull too high a vacuum, so we can control the amount of steam we use for the air ejectors accordingly. Their steam supply comes from the manoeuvring valve block that you can see against the forward bulkhead, along with the manoeuvring valves themselves – firmly shut at the moment, though with their warming through lines open.



Figure 38 – warming through line on main valve

In the figure you can see one of these bypasses straddling one of the steam valves on the Queen Mary, which allows the lines either side of the valve to be warmed through without actually opening the main valve. This avoids “wire-drawing” of the seat of the main valve and also prevents unwanted movement of machinery for safety reasons. At the same time we set other engineers on watch to start the warming through procedures on all the turbines in this engine room, with the forward engine room staff doing the same.

8.3 Turbo main feed pumps

The boiler room engineers have been using the DA Assistant feed pump up to now, but as soon as we start to turn the turbines, they will be using the turbo feed pumps, so we will line those up as well; back down the ladders we go to the bottom plates where the pumps are situated either side of the two feed tanks. They are automatically operated via a discharge pressure sensor, so we'll start them up first. They are the same as the ones we used for the Scotch boiler earlier, though a bit bigger. As usual with any pump, we open the suction and discharge valves and all the valves in the feed lines to the boilers. These are complicated but can be seen in the composite feed drawing later (Figure 67). We start by cracking steam on the turbine drivers of these pumps, which again is taken from the main valve block the same as the air ejectors are. With the exhausts open to the LP heaters on either side, the pump will run up to speed. After warming through, we can open the steam valve fully and leave the pumps (we will start one per side) to their own devices; any further attention will be from the boiler room engineers.

8.4 Turbine LO pumps, coolers and auxiliary seawater circulating pumps

The LO and seawater pumps seen in the earlier plans are now started up, beginning with the LO pumps themselves. Lining up the inlet and outlet valves and all the LO valves on the turbines, we start the pumps in the usual way.

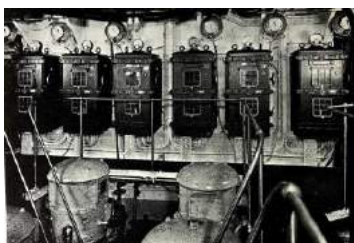

Figure 39 - A row of DC starter boxes mounted on the bulkhead

We start the LO pumps first as starting the seawater pump first could, in the event of a tube leak, cause seawater to leak into the LO system, which is to be avoided in steam turbines; it's far better – though not advisable – to have oil leaking into the seawater. Once the pumps are running, we check round as usual ex-dry-dock for any LO leaks on the equipment, following the lines around the machinery, both port and starboard. We can check the turbine shut down now, whilst we still have no steam on the turbine other than warming through. Opening a locked test valve with the steam inlet valve open we can drop the control oil pressure off the system and make sure it shuts the steam inlet valve to the turbine. That done, we lock the test valve and shut the turbine inlet valve again. All good.

Now we open up the seawater valves on the auxiliary seawater cooling pumps and coolers from suction to overboard and start the seawater pumps on both turbine sets. Checking around for leaks again and observing the pressures to be satisfactory, and we can move on to the next task.

8.5 Pervac extraction pumps

We need these pumps for controlling the level of the condensate in the bottom of the condenser and delivering the feedwater to the suction side of the turbo feed pumps. As mentioned in the feed system in an earlier section, these pumps draw from either the condenser well or the feed tank and discharge either to the feed heaters or back to the condenser well depending on the condenser water level.

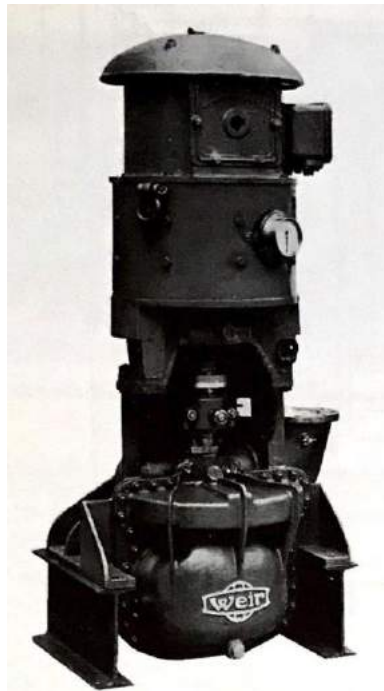

Figure 40 - Weir Pervac extraction pump

As seen in the picture, these pumps are electric motor driven and started in the usual way after opening up all the valves in the feed system on the suction side of the turbo main feed pumps. The pumps draw from the condenser well and discharge through the Air Ejectors, the Drains Coolers and the LP Heaters to the suction rail of the main feed pumps. Until the latter start drawing from the suction the Pervac pumps will run – once the condenser level is normal – from and back to the condenser, so we can leave them like that as they will respond to the condenser level changes once we use more steam.

8.6 Lining up the feedwater system from main feed pumps to the boilers

This ship has many duplicate systems, one of which constitutes the feedwater system. Currently we aren't using much steam as we only have generators running. However, that's not that much and can be handled by the hotel generator sets and however many main generators we have running. The main boilers are for the propulsion, which uses a vast quantity of steam in comparison, and we'll use a bit of this when we get a test turn on the main engines.

The after engineroom steam supply comes from Boiler rooms 5 & 3 – No 3 being smaller than No 5. Conversely, the forward engineroom steam supply comes from Boiler Rooms 4 & 2 where once again Boiler Room 2 is smaller than No 4. This gives a good split between smaller and larger boilers to serve the two enginerooms.

The feedwater discharges are similar in that each engineroom has its own feedwater system, more or less identical to each other, and whilst we were setting up our after engineroom, the forward engineroom watchkeepers were doing the same in their domain.

From the drawing in Figure 37 – Fr 108 Looking forward, we can climb the ladders to each heater and make sure all the requisite valves are open to both the main flow from the pumps and also the heating steam inlets and condensate outlets, along with the discharge to the feed checks on each boiler.

Below is a section from the main steam, feed and condensate systems in our after engineroom (Figure 41). It's a bit complicated for the uninitiated, but easy enough to follow once you can get your head round it, which you will have to do in the subsequent voyages back and forth across the Atlantic. However this is a massive ship, and you will have to learn it step by step as you go on, with the help of the other engineers, especially your senior watchkeeper – most likely one of the Assistant Second Engineers.

All that we have done so far on the feed system is replicated in the drawing, and you can start by identifying the various bits of equipment with reference to the sectional and plan/elevation drawings. The seawater and LO systems are not shown, but they are part of the turbine system and not the steam and feed. The Pervac pumps discharge through the suction side heaters (Air Ejectors, Drains coolers and LP heaters) to the feed pump suction rail. From there the turbo pumps discharge via the feed filters, IP heaters and finally the HP heaters at the top of the diagram, and thence to the boiler checks (note, the “checks” are the feedwater valves mounted on the boilers, and comprise main and auxiliary checks, the main checks being those fed by the feedwater controllers).

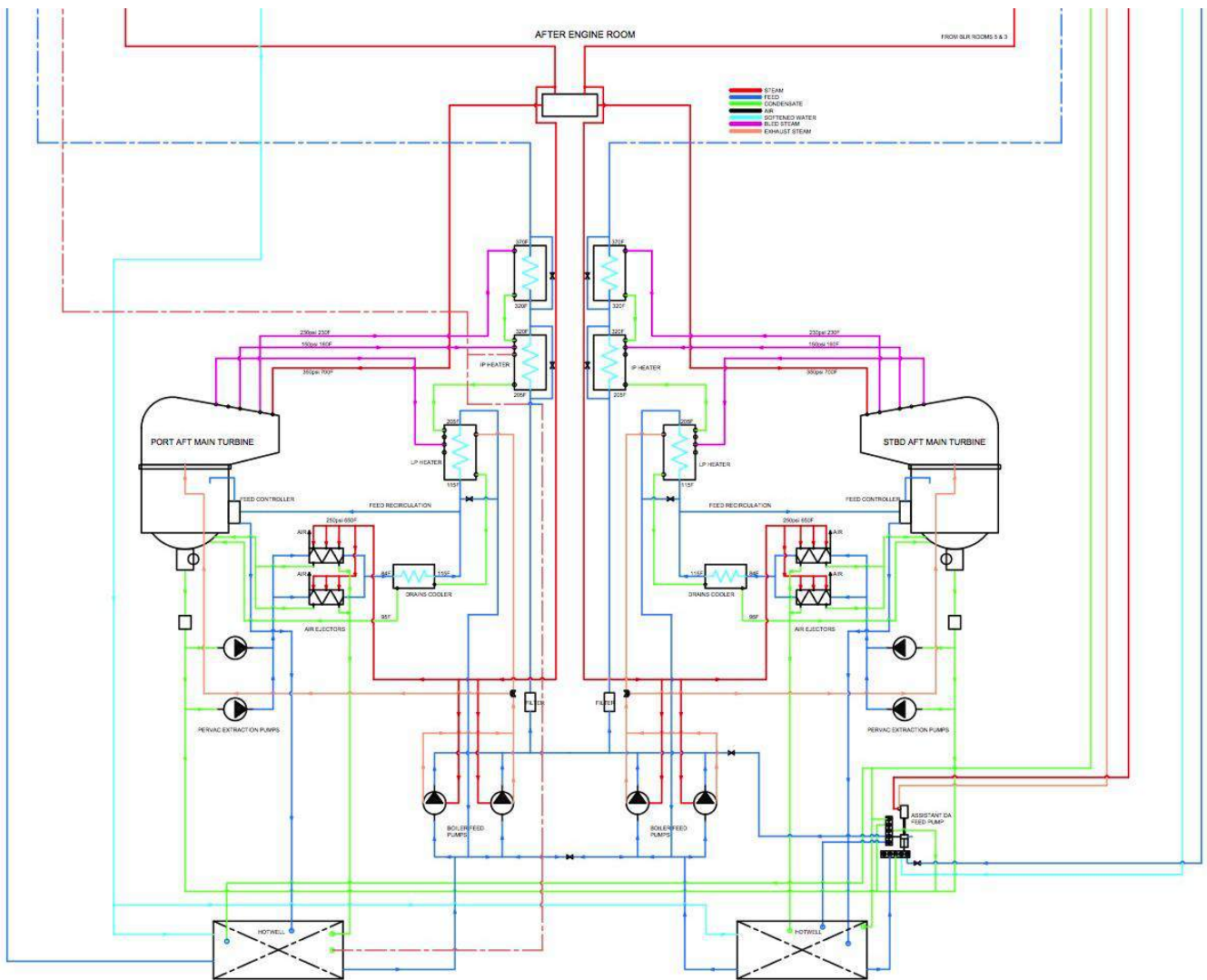

Figure 41 – AER Steam, Feed & Condensate system

9 Turning the main engines

We are now ready to get a turn ahead and astern from the main engines in our after engine room – quite exciting!

9.1 The turning gear

The turning gear is a device which comprises an electric motor which turns a gear that engages in the flywheel of the main engines. It is used to keep the turbines turning so that the rotors don't sag under their own weight and cause the moving blades to impinge on the stationary blades.

In the photo below from when the turbines were being erected in the machine shops of the shipbuilder, you can see the flywheel in the foreground, attached to the output shaft of the gearbox. Turning this flywheel will transmit back via the pinions in the gearbox to turn the HP, IP and LP turbines mechanically to ensure they are free to turn prior to using steam. Also in the photo are the HP valve chest nozzle valves, the four square ended spindles bolted to the HP steam chest on top of the HP turbine. The engine shown is the starboard after turbine set; next to the HP turbine is the 1st IP turbine on this after side of the gearcase. On the forward side of the gearcase is the LP turbine (opposite the HP) and the 2nd IP turbine opposite the 1st IP turbine. The large outlets on the top of the LP turbine connect to the large elbow bends that exhaust the turbines to the condensers, and you can see these in the background in the photo of the engine room today (Figure 43 – Starboard after nozzle bank today). The engines have been warmed through with the rotors turning under the turning gear, which we now retract to avoid any damage when turning the engines.

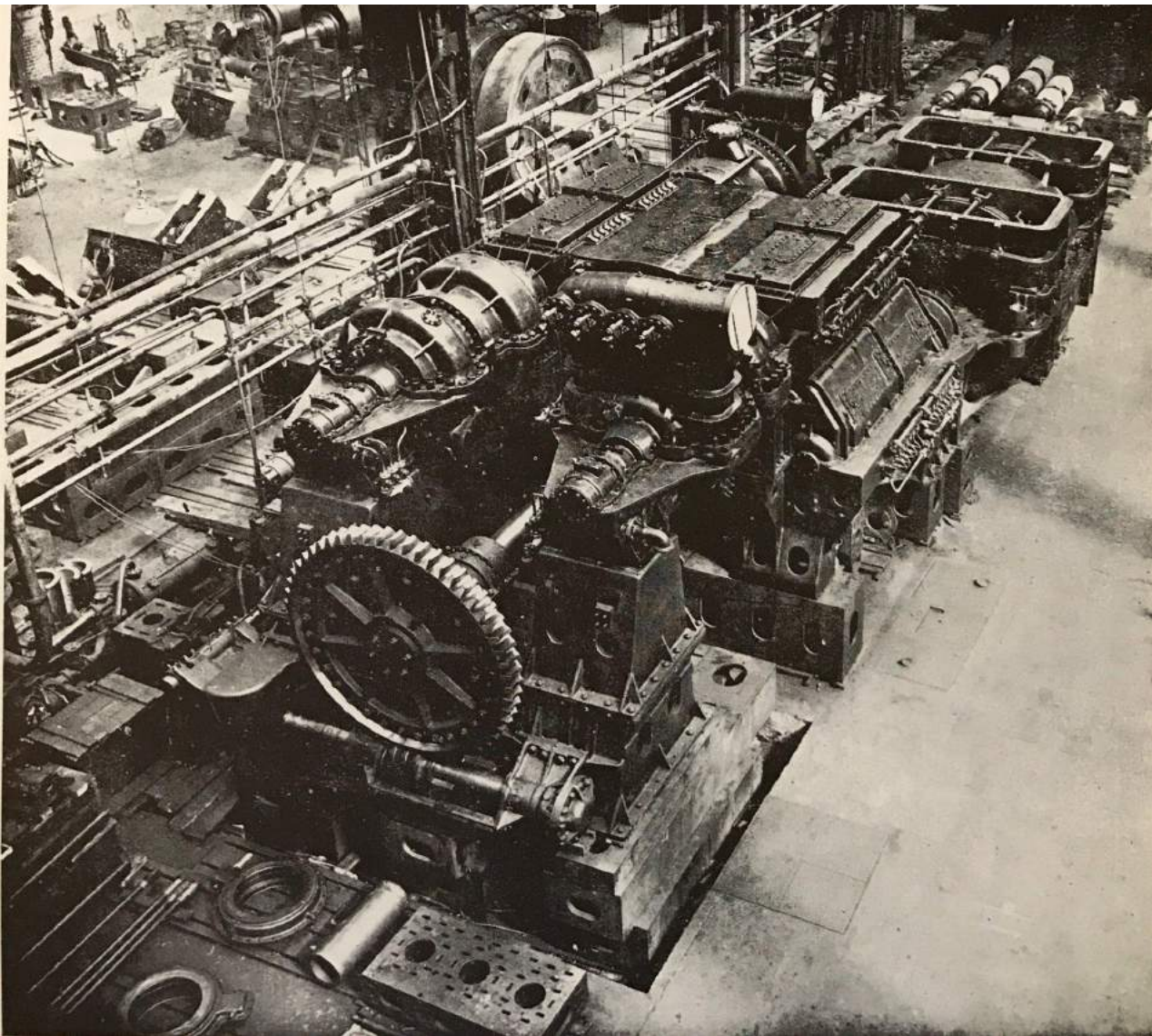

Figure 42 - Starboard after turbine set in the erection shop



Figure 43 - Starboard after nozzle bank today - on top of HP turbine

The exhaust from the turbine is open to the main condensers, so we can go through a turbine starting sequence as follows –

9.2 Main propulsion turbine starting sequence

9.2.1 Gland Steam

Whilst warming through, the gland steam is off, but we now need it on in order to avoid steam issuing from the glands when we open the main stop valves. This very important system refers to sealing the ends of the turbine shaft, both at the high-pressure and low-pressure ends. Without gland sealing, steam at the high-pressure end would issue out of the glands, and at the low-pressure end, the air coming in would destroy the all-important vacuum.

Prior to start-up, full steam is turned on to both glands or each turbine whilst the vacuum is being raised, and is maintained until full load has been on the turbine for some time. The vacuum by this time will have probably reached its maximum, or perhaps fallen to a point slightly lower, at which height it may be expected to remain, other conditions also remaining constant. The gland steam is then gradually turned off until the amount of steam vapour issuing from the glands is almost imperceptible – i.e. it is balancing the internal pressure or vacuum. This should not affect the vacuum as the glands are still sealed. Gradually the gland steam can be further reduced, until no steam vapour at all can be discerned issuing from the gland boxes. This reduction should be continued until a point is reached at which the vacuum is affected, i.e., when the outside pressure starts to overcome the steam pressure, whence it must be stopped and the amount of steam flowing to the gland again increased very slightly, just enough to bring the vacuum back again to its original height. The steam now passing into the glands is the minimum required under the conditions, and should be maintained as nearly constant as possible throughout the voyage. Practically all steam entering the glands is drawn into the turbine, and thence to the condenser, under which circumstances it may be assumed the increase in steam consumption arising from this source, is also a minimum.

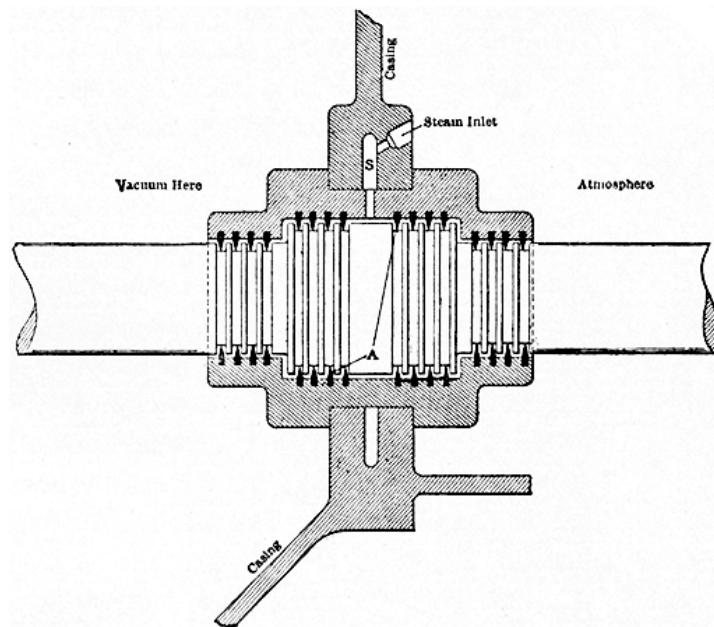

Figure 44: Gland sealing system

In the drawing above, with the turbine at rest and the gland steam on, steam from the inlet would flow both into the vacuum and out of the end of the gland to atmosphere. Adjustment of the steam inlet such that the effect of the vacuum overcomes the atmospheric pressure, will cause more steam to enter the vacuum space than issues to atmosphere. The right point is reached when steam no longer issues to atmosphere when it can be assumed that all the steam is entering the vacuum space with no air being drawn in. We leave one of our Juniors to keep an eye on this system and adjust it as required during manoeuvring.

- **Note:** On modern steam turbines, the gland steam system operates automatically.

9.2.2 The main stop valves

When the steam lines are warmed through along the length of the vessel, from Boiler Room 2 to Boiler Room 5, the various steam traps in these lines are blown through with the stop valves on the boilers cracked open about 1½ turns. As the lines warm through, the boiler stop valves are opened further until full open, and the steam pressure raised to 400psi. The Bulkhead Stop Valves, which are the isolators between the boiler rooms and the enginerooms, are also opened so that the engineroom lines may also be warmed through. This important consideration on steamships is rigidly adhered to in order to avoid water hammer and possible damage to piping and valves.

Below is a clip from the steam piping drawing, showing the bulkhead stop valves for the after engineroom. The drawing shows the direction of the steam arriving from the piping from the boilers in Boiler Rooms 5&3, and the red line is the bulkhead between the FER and the AER. The bulkhead stop valves are labelled "Self-closing emergency stop valves" which is indeed what they are, as any overspeed or irregularity on the turbines will cause these valves to close, shutting off the steam to the turbines. Putting steam on the turbines is relatively simple, but still requires a bit of practice in order to match the required speed from the bridge on the engineroom telegraphs. Turbines have large rotating masses, and getting them spinning – if carried out too energetically – could result in the turbine running away, with the engineer frantically closing the manoeuvring valve again. This is to be avoided as the Chief Engineer or Senior Second will probably be breathing down your neck to make sure he doesn't have to have a chat with the Captain after standby on why the ship came ahead/astern too fast. During manoeuvring, the astern isolator is left open to allow quick changes from ahead to astern and vice versa, but at sea it is left firmly shut. In an emergency astern movement at sea, astern steam can be used as "braking steam" in order to overcome the windmilling effect of the screws under the 30-odd knots momentum of the ship.

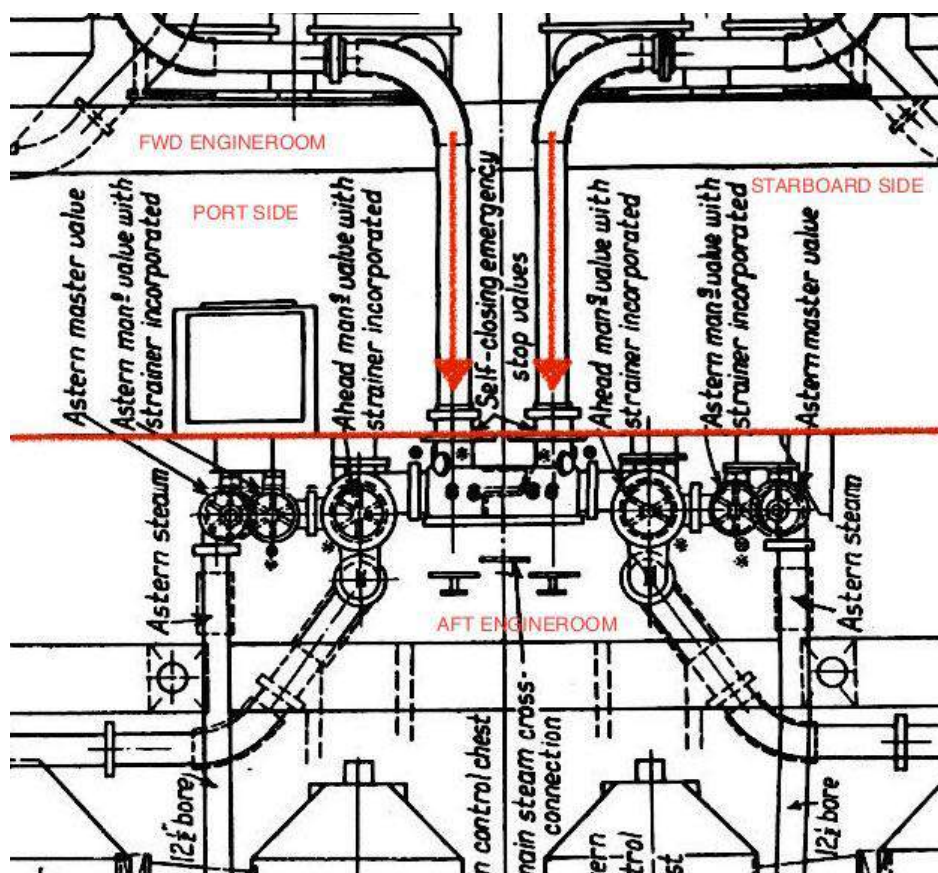

Figure 45 - AER Bulkhead Stop Valves

- with a photograph of the handwheels that operate the manoeuvring valves on the starting platform for the port and starboard inner engines:

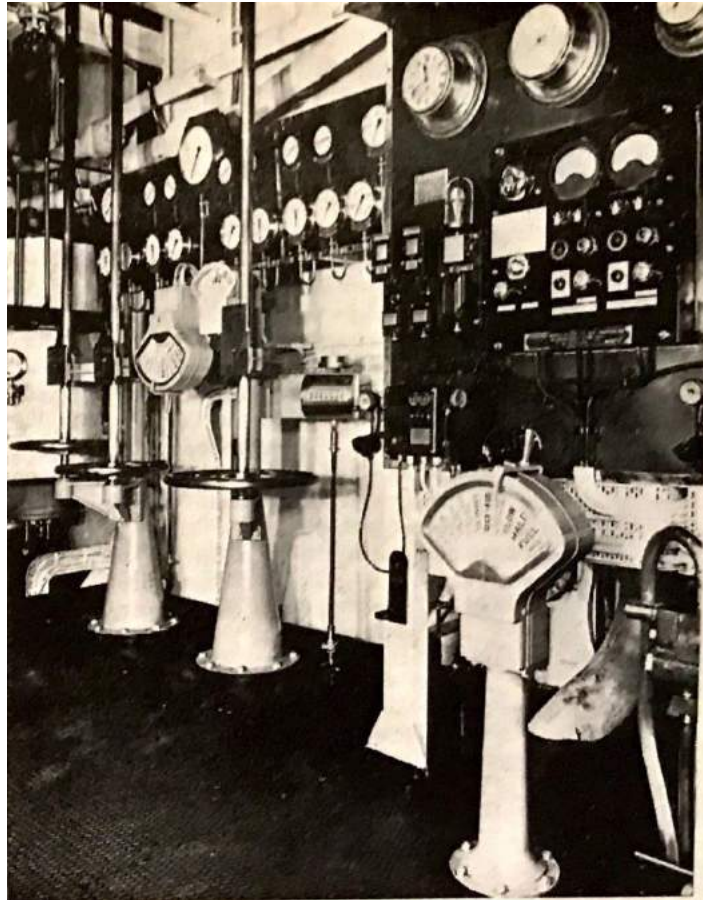

Figure 46 - FER Starting Platform

(This photo is the FER, but the AER is similar). Referring to the drawing and the photo above, the three handwheels shown are, from left to right –

- The “Astern Master Valve” (sometimes called the Astern Isolator or Astern Guardian valve) which stops steam being admitted to the astern turbines when the Ahead steam valve is open.
- The Astern Manoeuvring Valve – which admits steam to the astern turbines
- The Ahead Manoeuvring Valve – which admits steam to the ahead turbines

The spindles pass up to the manoeuvring valves mounted over the starting platform (as seen in Figure 37 – Fr 108 Looking forward).

This will be your position when we start to manoeuvre, as you will be carrying out the orders from the bridge transmitted to the telegraph that you can see between the ahead and astern throttle wheels.

9.2.3 Trial ahead and astern movement

We are all ready to go, and have the following systems running under the supervision of the engineers in each space –

- * All required main generators on the board (usually four on standby), with the main system isolated from the hotel system, and turbines running on main steam lines (previously from auxiliary steam lines)
- * All condenser levels correct, extraction pumps running, vacuum raised to maximum ready for starting required number of main feed pumps, with first one started
- * Boilers up to 400psi with superheater drains cracked open sufficient to drain the lines; all water levels correct.
- * Turning gear removed

- * Manoeuvring valves cracked open sufficiently to drain lines, but not sufficient to turn the turbines. All turbine drains open. Turbine poker gauge readings and sliding feet readings taken and checked (to ensure turbine fully warmed up and the blades are not binding)
- * Remaining seawater circulating pumps started
- * Start second main feed pump
- * Starting platform engineers warn boiler room engineers by telephone of the impending turning of the main engines
- * One HP turbine nozzle chest valve is opened – this will supply enough steam for us to work the passage at standby Full Ahead revs until we open up across the Atlantic on departure Queenstown.
- * In conjunction with the bridge, test main engine telegraphs, whistles, steering gear and synchronise clocks. Note times in Movement Book
- * Request permission from bridge to try engines ahead and astern

The bridge gives permission, and rings the telegraph for our engine (the port inner) to *Dead Slow Ahead*. You answer the telegraph, which stops the bell ringing, and turn the Ahead manoeuvring valve to the position for *DS Ahead* indicated on a brass pointer driven by the manoeuvring wheel.

Observing at the same time the steam pressure in the HP valve chest (there is a guide for the relative steam pressures for each manoeuvring speed) and the shaft speed indicator, you see the shaft revolutions start to rise to *DS Ahead* – be sure that the turbine doesn't "run away". Almost immediately the telegraph rings *STOP* and you close the manoeuvring valve. The revs drop and the shaft stops. The power in these turbines is considerable, and even at *DS Ahead*, the bridge can see the ship start to move against the ropes, hence the short period between ringing the order and *STOP*.

Note: The revolutions shown on the revolution counter are shaft revolutions, taken from the output shaft of the gearbox – they are not the turbine revolutions

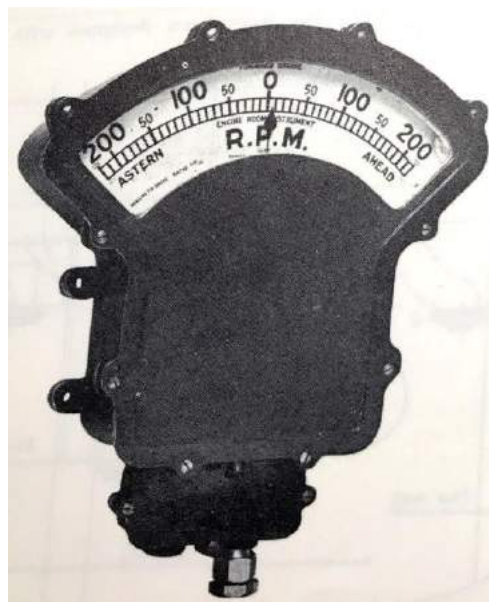

Figure 47 - Shaft Revolution Indicator

The telegraph rings again – *Dead Slow Astern*. Opening the Astern Master Valve, you then turn the Astern Manoeuvring valve observing the brass pointer attached to this wheel, and also observe the steam pressure in the astern turbine control steam chest. The astern turbines comprise three rows of impulse blading on the 2nd IP turbines, with the HP steam admitted to this blading exhausting to three rows of impulse blading on the LP turbines, both of which are on the same side of the gearbox – the forward side in our case.

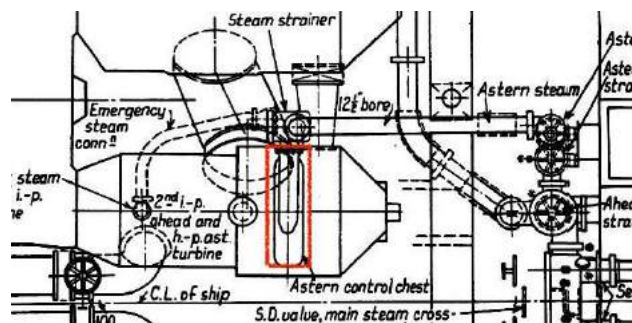

Figure 48 - Astern control chest

Once again you watch the shaft revolutions rise – in this case in the astern direction, and as soon as the shaft starts to move, the officer on the bridge rings *STOP* again. Rather short, but enough to test that everything is functioning correctly. You shut the Astern Manoeuvring valve, followed by the Astern Master Valve.

We are just about done here for the moment, and can relax with a cup of tea (it *is* an English ship, even if it *was* built in Scotland...) whilst we listen to the bells of the starboard inner telegraphs and watch our fellows on the starboard manoeuvring valves doing the same as we have just done. The forward engine room then has their turn, and we can see the outer shafts – which pass through our engine room – turning ahead and astern.

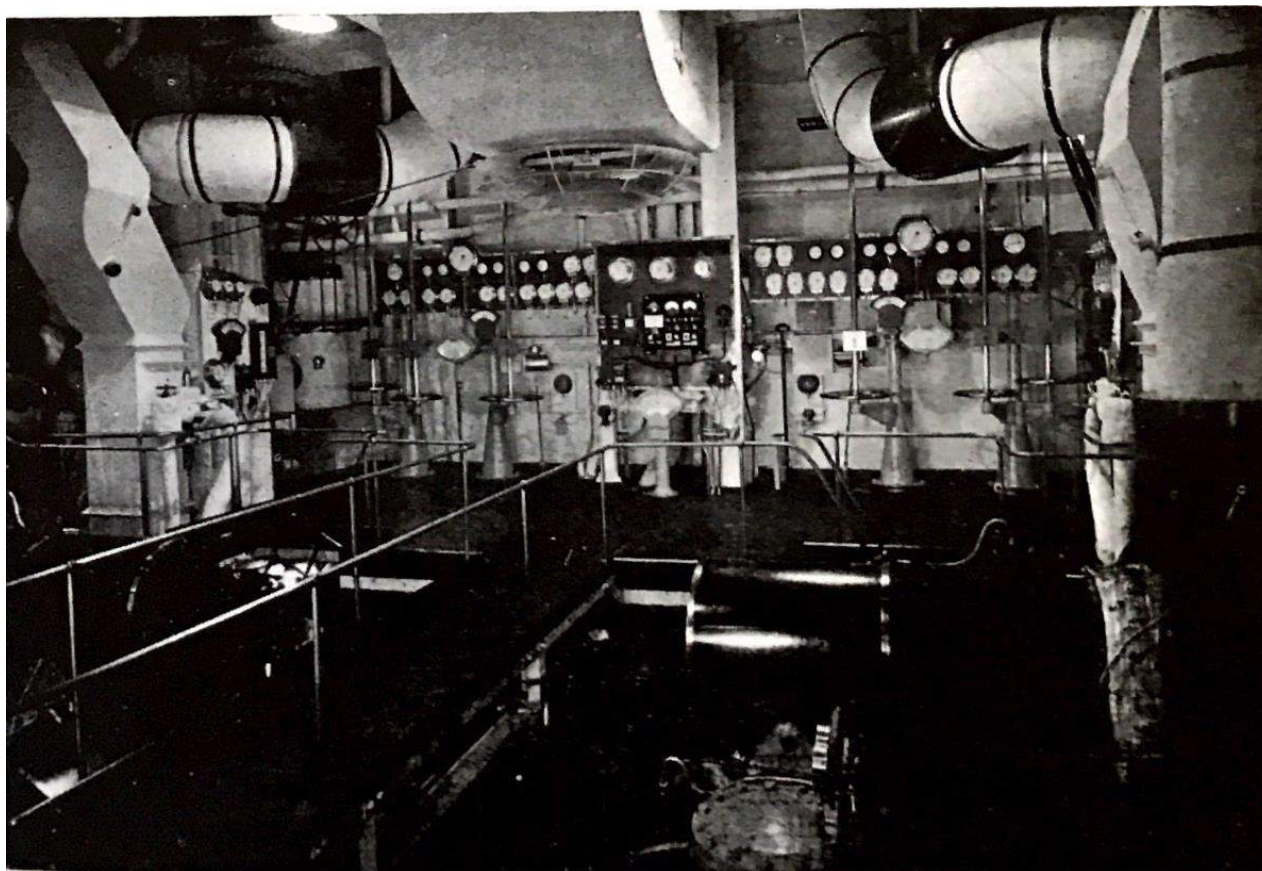

Figure 49 - AER Starting Platform 1934

You can see our manoeuvring wheels to port, and the mirrored set to starboard. Note the plethora of gauges above each – the important ones are the vacuum, nozzle chest pressures, turbine oil pressure, seawater pressure etc. Boiler steam pressure is also shown for each boiler room, and there are telephones to the bridge, turbo generator rooms, boiler rooms and the forward engine room. Note also the large superheated steam piping in the overhead, and the supply fan vents.



Figure 50 - AER Starting Platform today

Unfortunately the only part of the ship's machinery remaining that propelled her across the Atlantic for so many years in her glory days of holding the Blue Riband. All the rest forward of this bulkhead has gone forever, but we know what was there, don't we?

10 Getting under way

We are now down below again for the leaving harbour watch, again on the port inner turbine, which is our manoeuvring station in the after engine room. Everything is "burning and turning" and we are looking forward to heading off to New York via Cherbourg (France). We have done our final checks, tested the steering gear and telegraphs and synchronised the clocks. Each engine station reports to the Chief Engineer that they are ready for manoeuvring and the Chief calls the bridge to report "Main engines ready for sea service".

The telegraphs all ring "SBE" or "Stand By Engines", which we answer and note the time in the Movement Book for our engine.

Almost immediately (they don't hang about on timed departures) our telegraph rings "Dead Slow Ahead", and we hear the starboard inner telegraph ring as well – probably DS Astern to pull us off the berth. You answer the telegraph and open the ahead manoeuvring valve to the *DS Ahead* position, remembering to note the HP steam chest pressure is not exceeded for these revs.

Our telegraph rings again "Slow Ahead" and again you answer the telegraph and ease the wheel to achieve the correct steam chest pressure. The engine starts to speed up and you note the shaft revolutions aren't exceeded, easing the handwheel back a touch. The 2nd Engineer taps you on the shoulder and advises you to open the Astern Master Valve in the event of an astern movement. You

check that the Astern Manoeuvring valve is firmly closed, then swing the Master Valve open to give a faster response if required, and leave it open for the remainder of the manoeuvring out of port.

The telegraph rings “STOP” and you close the Ahead handwheel. Immediately afterwards, the telegraph rings “Slow Astern” and you respond again with the Astern manoeuvring wheel, again watching the shaft revolutions and the astern steam chest pressure.

Manoeuvring out of harbour can take some time, and the telegraphs are ringing almost constantly as the pilot eases the ship away from the berth and down Southampton Water to the English Channel. We are working hard down below whilst our passengers are waving to their friends and families on the quay far below them, but above us, as we are just about on the waterline!

The ship gathers way with all engines on *Half Ahead*, and makes her way across the Channel to the port of Cherbourg. Again we are still on standby to bring the ship to the anchorage off the port where the Cunard tender brings out the passengers who are embarking and those disembarking who just made the short trip across the Channel. The ship is here for a few hours only and we come back on watch as the ship leaves Cherbourg and makes her way out into the fairway and the Western Approaches to the Channel. A few astern movements are given, and then we are on *Half Ahead* for the trip down the English Channel; the passengers are on deck where there’s a bracing wind, and they can see the ports of Poole on the starboard side and the Channel Islands to the south off the port side.

The telegraph rings “Full Ahead” and you ease the wheel again, watching the shaft revolutions and steam pressure as usual. You cast your now more practised eye over the various gauges in front of you, noting that the vacuum is behaving itself (which it sometimes doesn’t) and that all pressures and temperatures are satisfactory.

The bridge informs the Chief Engineer that “FAOP” or “Full Away On Passage” will be at 1800hrs, which will take us off standby and allow us to work up to full speed. The time of FAOP is usually made to the nearest tenth of an hour, i.e. 0min, 6min, 12min, 18min etc. past the hour, for ease of calculating the various passage parameters. It’s normally signalled by the bridge, smack on 1800hrs, by ringing the telegraphs from *Full Ahead*, back to *Half Ahead* and back over to *Full Ahead* again.

Down below we answer the telegraph, the Junior notes it in the Movement Book and goes off with the Chief to dip the tanks and work out the standby fuel state to show the fuel used from arrival in port to standby leaving, and FAOP. This all goes on an abstract as big as a bed sheet, which is then fair-copied by the Chief’s Writer on to the fair copy of the abstract (of Engineroom Log) which is sent to the Company Offices each trip.

You keep an eye on the steam chest pressure, and as the turbine gathers speed, the steam pressure drops, so you keep it up with increments of the Ahead Manoeuvring valve. A point is then reached where the manoeuvring valve is full open, and it won’t go any further. Our 2nd gets us to climb up on the HP nozzle chest (Figure 43) and open up another one of the nozzle valves about half way; the turbine responds to this by increasing speed accordingly, and the valve will be opened further or another one of the four valves if we hit heavy weather*.

- * *On full chat the Mary had all four of these valves open on her record-breaking runs during the time she held the Blue Riband of the Atlantic. Towards the end of her days, she ran on only one open as the turbines were getting a bit tired after 30-odd years of transatlantic service and a war in between. On her delivery voyage to Long Beach, the engineers took a chance and opened all four up to see what she would do, and apparently she was off like the greyhound she’d always been! Swansong indeed...*

The two main forms for the control of turbines is explained below -

10.1 Throttle v Nozzle Governing

10.1.1 Throttle governing (steam turbine generators)

Generators are controlled via the throttle valve “*Throttle Governing*” as they are isochronous (constant speed) machines, with the throttle valve designed to carry out load changes without damage to the valve seats.

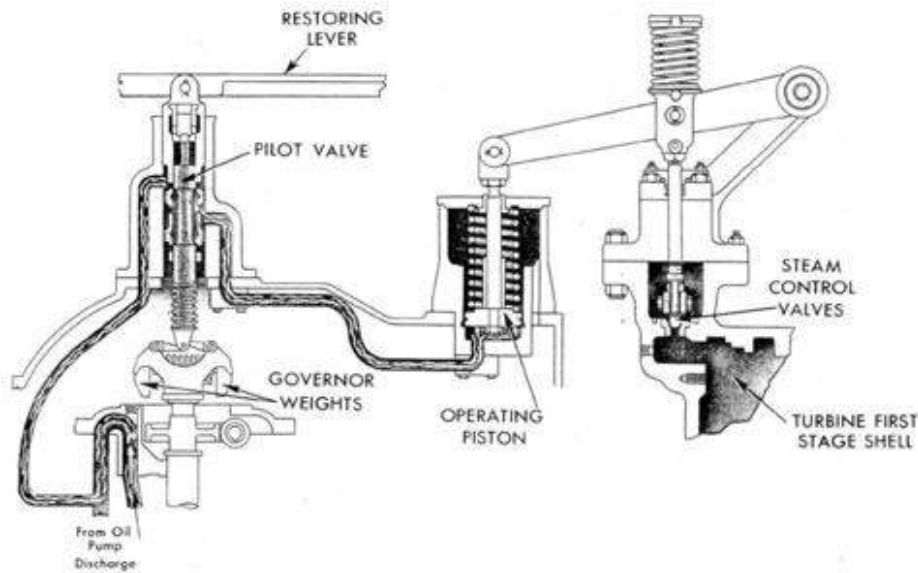

Figure 51 - Throttle Governing

The flyweights of the governor sense increased load change on the turbine generator, causing the pilot valve to feed oil via its sleeve ports to the servo operating piston on the turbine throttle valve, moving the control valve spindle up and opening the steam valve to the turbine further. When the load falls, the governor weights move in, the pilot valve spills oil back to the sump, and the operating piston moves down. The link from the operating valve to the control valve spindle moves down, closing in the steam valve to the turbine.

10.1.2 Nozzle governing

For the main engines it's extremely inefficient to control the engine speed via the throttle apart from when manoeuvring in port where precise control at low speeds are required. Once at FAOP the turbines are run on a fully open manoeuvring (steam inlet) valve, the one that has just reached its full open point. This avoids throttling the steam at the inlet to the turbine, thereby allowing the steam temperature to reach its designed value of some 400psi, 700°F and also avoids wiredrawing of the valve seat. This is known as “Nozzle Governing” used on this ship.

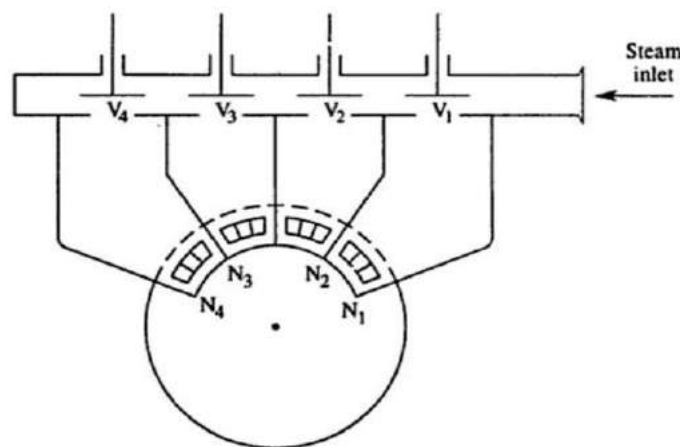

Figure 52 - Nozzle Governing (Sideplayer.com)

A dynamic arrangement of nozzle control governing is shown in Figure 52

In this arrangement the nozzles are grouped in four groups and each group of nozzles is supplied with steam controlled by the four valves on the steam chest of the HP turbines. The arc of admission is limited to 180° or less. The nozzle controlled governing is restricted to the first stage of the HP turbine, the nozzle area in other stages remaining constant. It is suitable for both a simple turbine and for larger units which have an impulse stage followed by an impulse reaction turbine, as is the case with Queen Mary's propulsion turbine sets.

10.2 Handing over the 4-8 watch

We are on our way! The 2nd sends you up top for ten minutes to have a look round and let him know when Lands End is astern of us, and we are heading into the setting sun. It's a bit chilly in your boiler suit and shorts (nobody wears anything more under their boiler suit unless it's really cold, which is rare...) but it's a fine sight seeing the ship's wake streaming astern of us under the impetus of the four massive screws – one of which you turned yourself!

Back down below in the shade again the Second has us tidying up and making a final mug of tea to help us through the last two hours of the 4-8 watch before sending us off to collect data for the engineroom log at the end of the watch – which takes some time on a ship this size. We start at the forward end in the Water Softening plant room where not much is happening, then on into No 1 Boiler room, and it seems a long time ago since we were there the day before yesterday. Moving aft through the airlocks to Boiler Room 2 we notice that the ramp plates that allow wheeled carts to travel through the watertight doors in port have been removed and stowed alongside the doors, as they would impede the closing of the WT doors in an emergency. We can still walk through the air locks however, as the WT doors will remain open unless we *do* have an emergency. The boiler rooms are now a hot roaring place with all the forced draft fans operating, and the fuel oil heaters all ramped up; the fires are at full blast and the steam pressures are spot on at 400psi. We run up the ladders to the top of the boilers and check the fan starters and note their current and voltage readings. Back down again we go aft through the airlocks to the forward turbo generator room and take the readings from the condensers, turbines and the switchboard – noting it all down on a clipboard. With experience you can remember all this data and just regurgitate it into the log afterwards, but that takes some time on a ship this size, with many engineers never managing to achieve that sort of memory retention! Back aft we go again, through boiler rooms 3 and 4, taking readings as we go, and into the after turbo generator room. The generator rooms are quite quiet compared to the boiler rooms, and as for the forward TG room, we take the various log readings as we check round. We continue on through Boiler Room 5, again a roaring space of hot oil, steam, hot lagging and burning paint from where the dry-dock gangs repainted some of the boiler mountings with heat-resistant aluminium paint. Some of the lagging is also giving off vapour smells where oily hands have handled it during maintenance. Again we run up the ladders to check the fans, and note the water levels and steam pressures on our clipboard

Then it's into the forward engineroom where we nod to our fellows who are doing their own log. Even so, we check round to make sure everything is OK as we are on *THE 2nd Engineer's* watch (he's the Senior Second, and responsible for the whole of the machinery throughout the ship, reporting only to the Chief Engineer). He changes about from space to space and we will probably have an assistant second tomorrow, whence the other spaces will take their log themselves and write it up in a separate log. We will then only be responsible for taking the readings in the after engineroom – our working home for the next few voyages.

From our domain we carry on aft and check out the shaft tunnels and shaft bearings, making sure that the oil is splashing over the bearing collars and that the seawater supply to the bearings is keeping them cool (the thermometer is marked with the appropriate temperature as the Atlantic doesn't change much, so we check that it's not over the chinagraphed line on the instrument). Then it's back to the AER and aft to the steering flat to make sure everything is OK there as well, and our job down

below is done. We will have to check the refrigeration temperatures at some time, but today a Junior has waltzed off to do that for us.



Figure 53 - One of the shaft tunnels - a gloomy place

The fridges and cold rooms are on D Deck, the same area as the engineer's messroom. The 2nd is pleased with your performance so far and offers to buy us a pint each in the wardroom after our watch, which is damned sporting of the fellow I must say. Nice to be in his good books, and he will give a favourable report to the Chief too. Lots of Brownie Points for you, so keep it up... We have taken the seawater temperature in each space, and report the lowest reading found to the bridge over the telephone. They use it to give advanced indication of weather changes such as fog and ice (thinking Titanic here...).

That's it, it's 2000hrs, our reliefs arrived at 1945, we're done and now have a couple of pints to look forward to once we have grabbed a meal in the messroom, showered and changed into "rig of the day", which is "Red Sea Rig" in the wardroom (within the Senior Officer's Quarters on the Sun Deck) tonight, comprising white open necked shirt with rank epaulettes, black trousers and black shoes. A cap is worn throughout the accommodation in case you come into contact with passengers, though this is always left outside the wardroom on the row of cap hooks mounted for the purpose; entering the wardroom wearing it will cost you a round of port or a case of beer, depending on how the Mess President sees the felony. There were myriad uniforms in passenger ship companies in those days, for informal and formal wear as promulgated in the "Rig of the Day". You are well advised not to make any mistakes in what rig you wear.

After our two beers and a chat with others, we go off to our respective cabins to get our heads down before going below 15 minutes before the next watch at 0400 hours in the morning. We will keep up this "four on, eight off" for the 5 days or so it takes to cross the Atlantic at 30-odd knots, where we

should be able to get some shore leave to have a look at the City of New York on the other side of The Pond. See you tomorrow!

11 The Movement Book

You may be wondering about the Junior Engineer and his Movement Book. This important book records all the engine and bridge telegraph movements during manoeuvring, and both the engineroom and bridge copies should correspond. In the event of an accident, the Movement Books are one of the documents that would be required in an Enquiry, and if they don't tally, or are altered in any way, something fishy has gone on. For this reason, any alterations are to be crossed out, signed, and the proper order written underneath – no "Snow Pig" allowed either - and no spaces are allowed between movements. The bridge and engineroom clocks are synchronised at Stand By for this reason. Nowadays there are bridge voice and telegraph "black boxes" similar to those carried on aircraft, but the good old Movement Book stood the test of time for over a century.

12 The Engineers accommodation

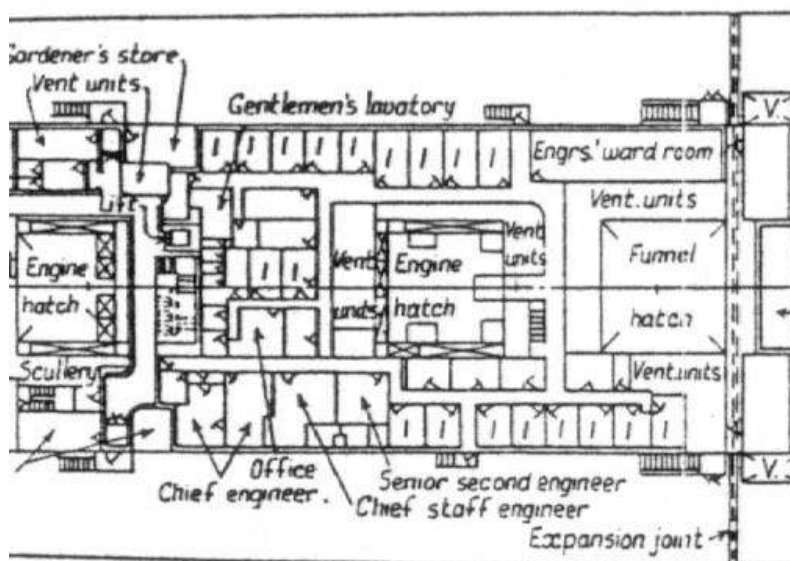

Figure 54 - Senior Engineers Accommodation and Wardroom on Sun Deck

We head up here to the wardroom for our free beers off the 2nd Engineer. Make sure you are in the Rig of the Day. Head down the port side alleyway from the lift, not the starboard in case you bump into the Chief.



Figure 55 - Cunard Officer's Mess Kit

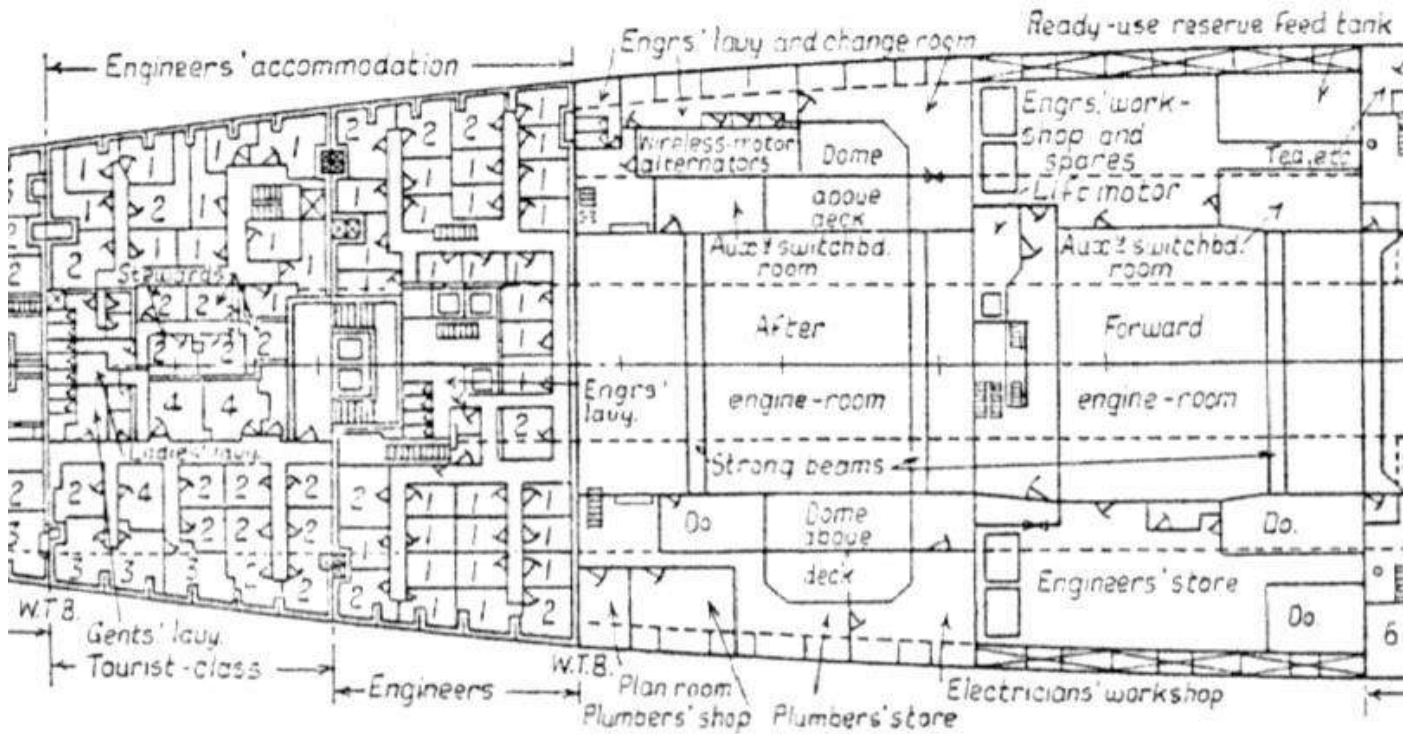

Figure 56 - Junior Engineers Accommodation on E Deck

As a Junior Engineer, you would share a cabin with another Junior or Engineer Cadet – pick a 2 berth cabin and try to remember how to get there! You don't have your own bathroom, so use the Engineers Lavatory and Changing Room before heading down below or coming up after your watch.

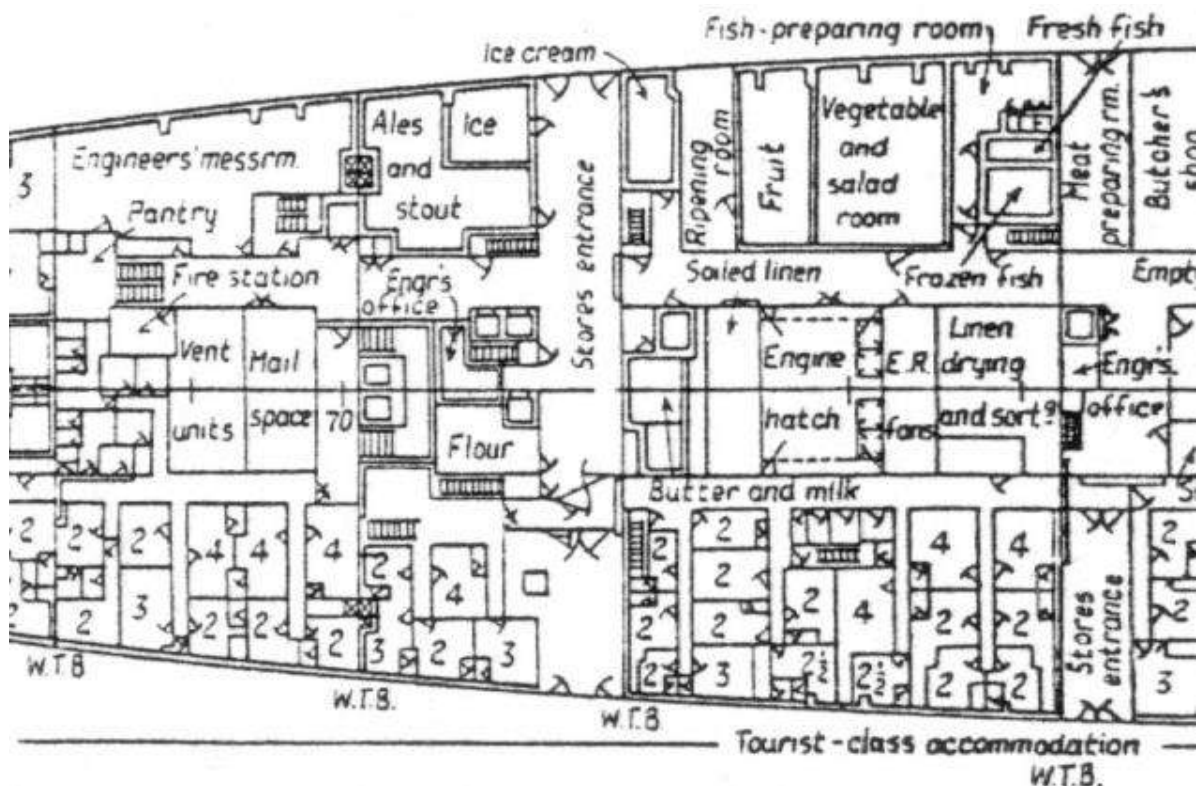

Figure 57 - Engineers Messroom and Provision Cold Rooms on D Deck

We use the messroom for all our meals, unless you get an invitation to the Wardroom or a passenger area table, which was common in some passenger companies such as P&O, but not Cunard. You get to the messroom from the FER lift into the working alleyway (known as *The Burma Road* on the Queen Mary and many other ships – a RN warship, *HMS Glamorgan's* (a county in Wales) working alleyway was known as *The Rhondda Valley*). Also in this area is the Engineer's Office where paperwork was managed.



Figure 58 - The Burma Road - Working Alleyway, Port side D Deck

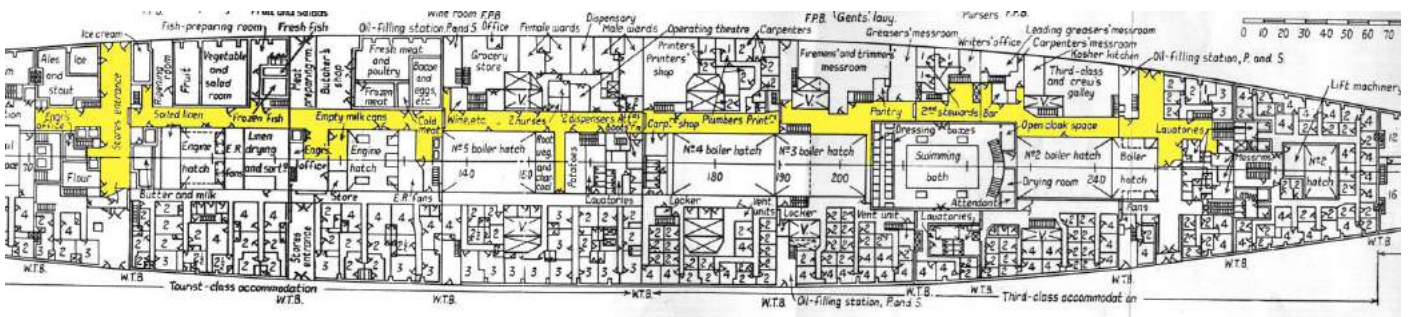
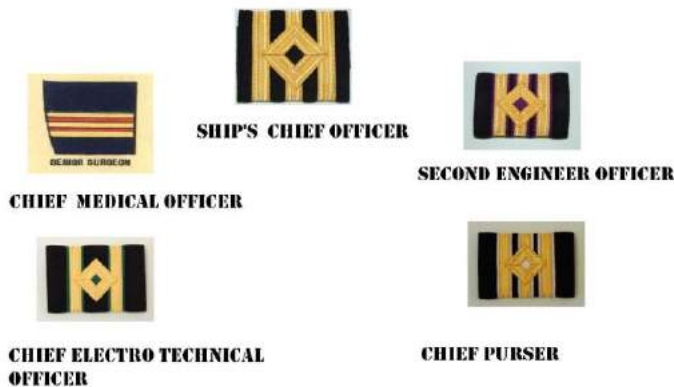

Figure 59 - The Burma Road running through the ship on D Deck

(<https://www.sterling.rmplc.co.uk/visions/cdeckwa.jpg>)

**DIFFERENT COLOURS BETWEEN THE STRIPES,
MERCHANT NAVY UNIFORM, INSIGNIA
:MARINE_OBSERVER CDT. A. TIWARI**



Sample braid of the British Merchant Navy. The cloured inserts denoted –
No colour – Deck Officers
Purple – Engineer Officers
Green – electrical Officers
White – Pursers
Red – Medical

The “diamond” or a “curl” (per the RN) was used in different positions. Cunard’s diamond was on top of the braid similar to the RN curl. Standard MN braid per the picture, with the diamond within the braid. Canadian Pacific had a Maple Leaf instead of a curl or diamond, some have a propeller emblem for Engineers or an anchor for Deck Officers.

13 The Forward Engine Room

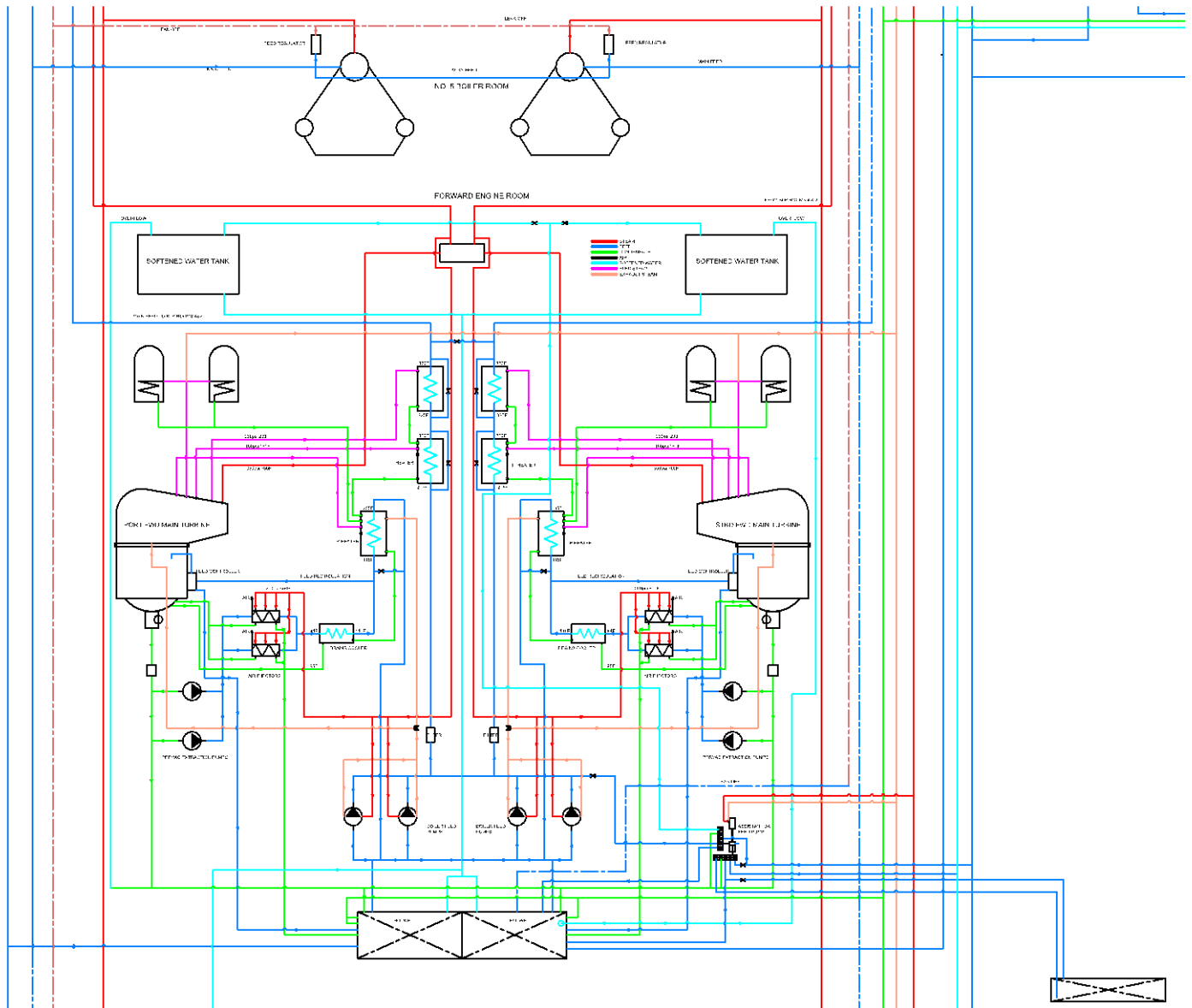

Figure 60 - Forward Engine Room Steam, Feed and Condensate diagram

The above diagram can be matched to the plan and elevation of the FER below -

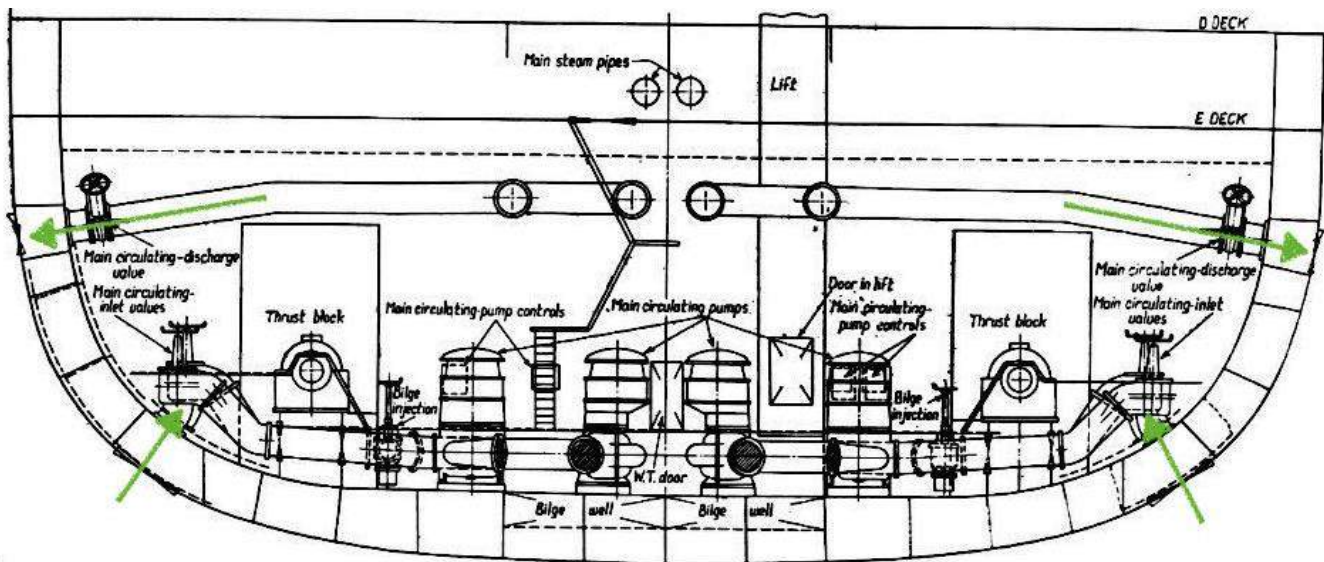

Figure 61 - Section at Fr 116 looking aft (FER)

In the above drawing you can see the lift, the four seawater-circulating pumps and the suction and discharge valves for the condenser seawater circulation system

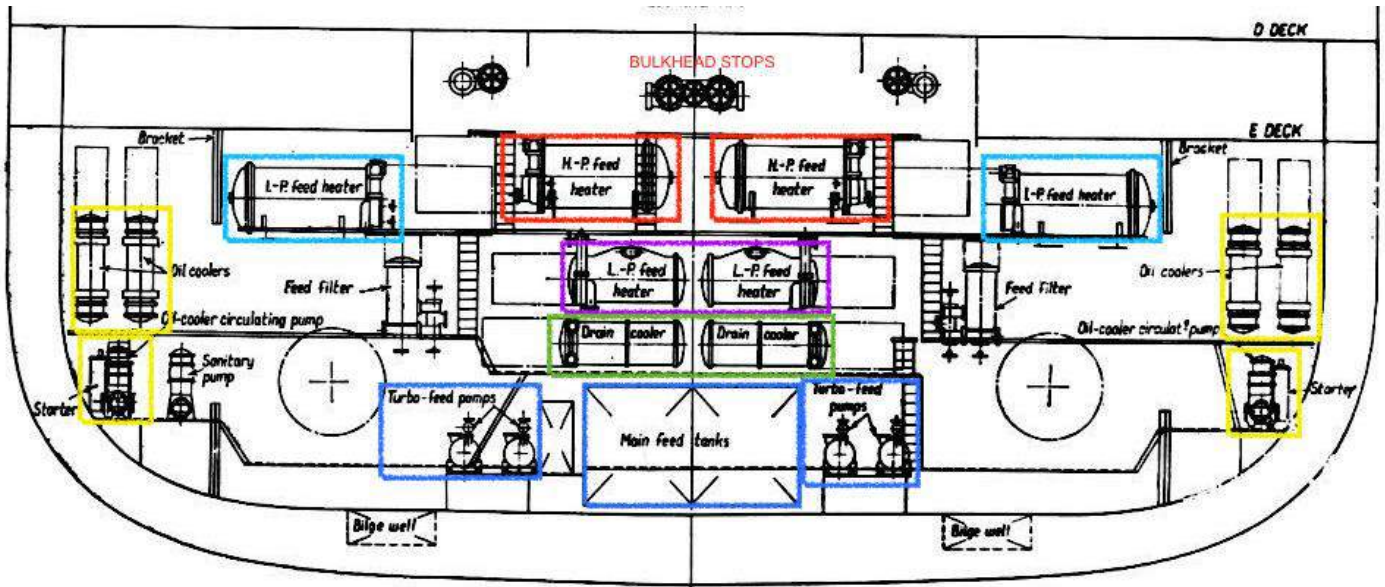

Figure 62 - Section at Fr 134 Looking Forward (FER)

In the above drawing are shown the various feed heaters discussed previously, along with the LO coolers, feed tanks and boiler feed pumps in this space. Essentially it is identical to the AER in terms of equipment. Also in the view are the bulkhead stop valves for the FER (the centre pair) and the AER (the outer pair). For the plan and elevation of the space see Figure 32.

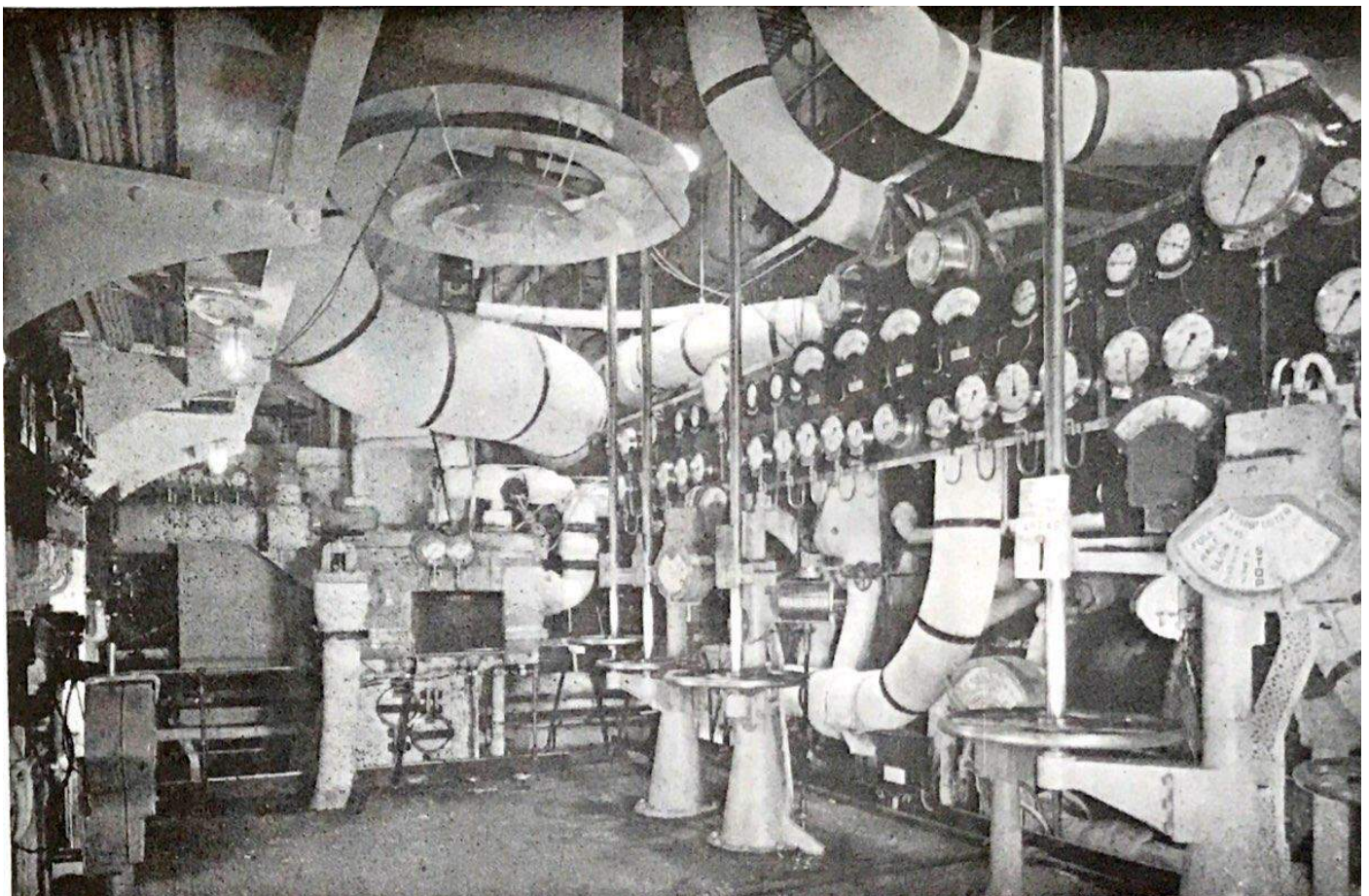

Figure 63 - FER starting platform

Showing the symmetry with the AER. The large gauge shown is probably the vacuum – eyes are usually glued to this gauge when manoeuvring, as if the vacuum fails, so does everything else...

14 Boiler rooms and auxiliary systems

14.1 Boiler rooms 2 to 5 – steam, feed and condensate

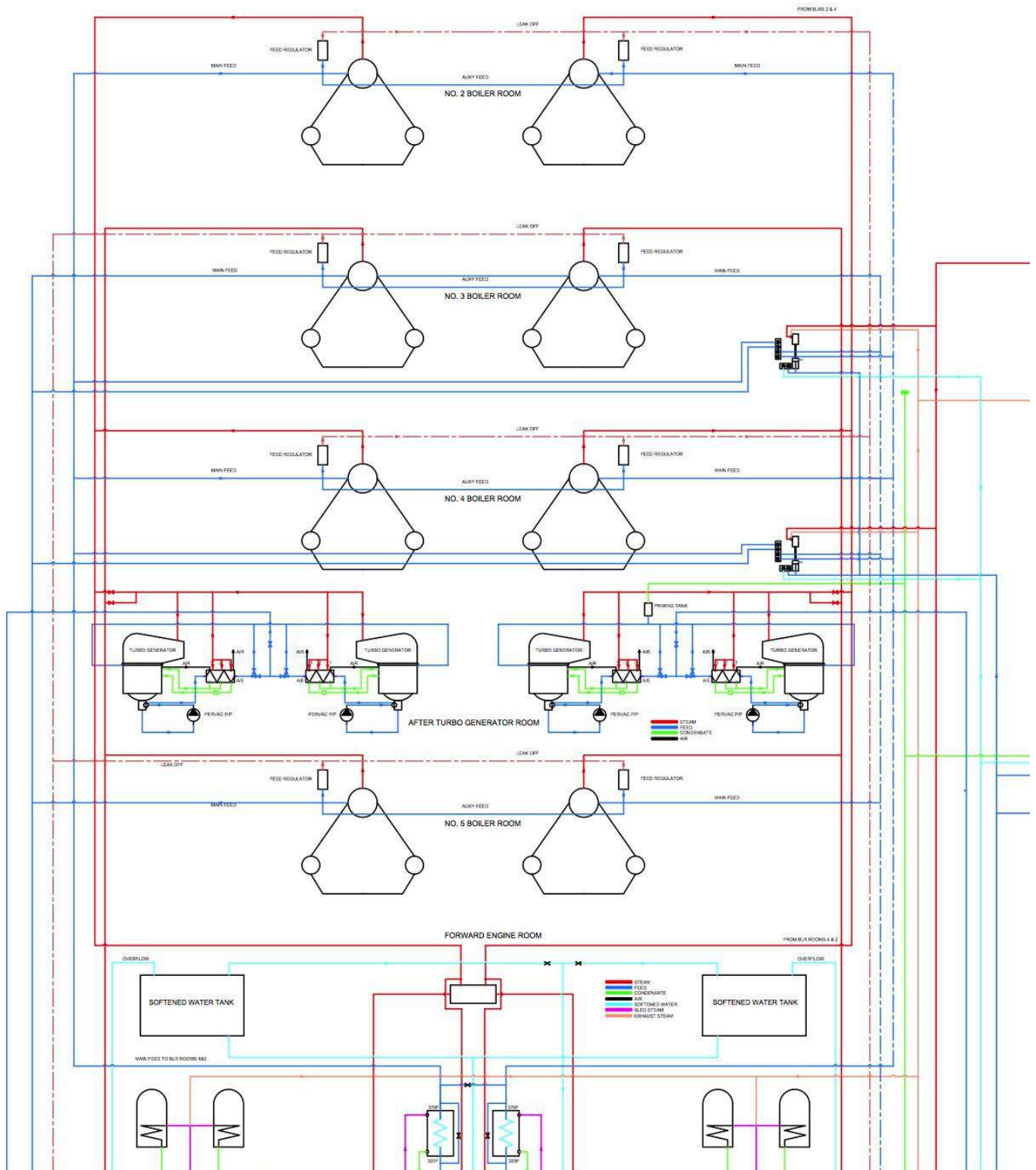

Figure 64 - Boiler rooms 2 to 5 and Main TG room

Here you can see the main propulsion boilers, after main TG room, single cylinder feed pumps and the steam lines to the FER bulkhead stops.

14.2 Auxiliary (No1) Boiler Room and forward hotel generator steam, feed and condensate systems

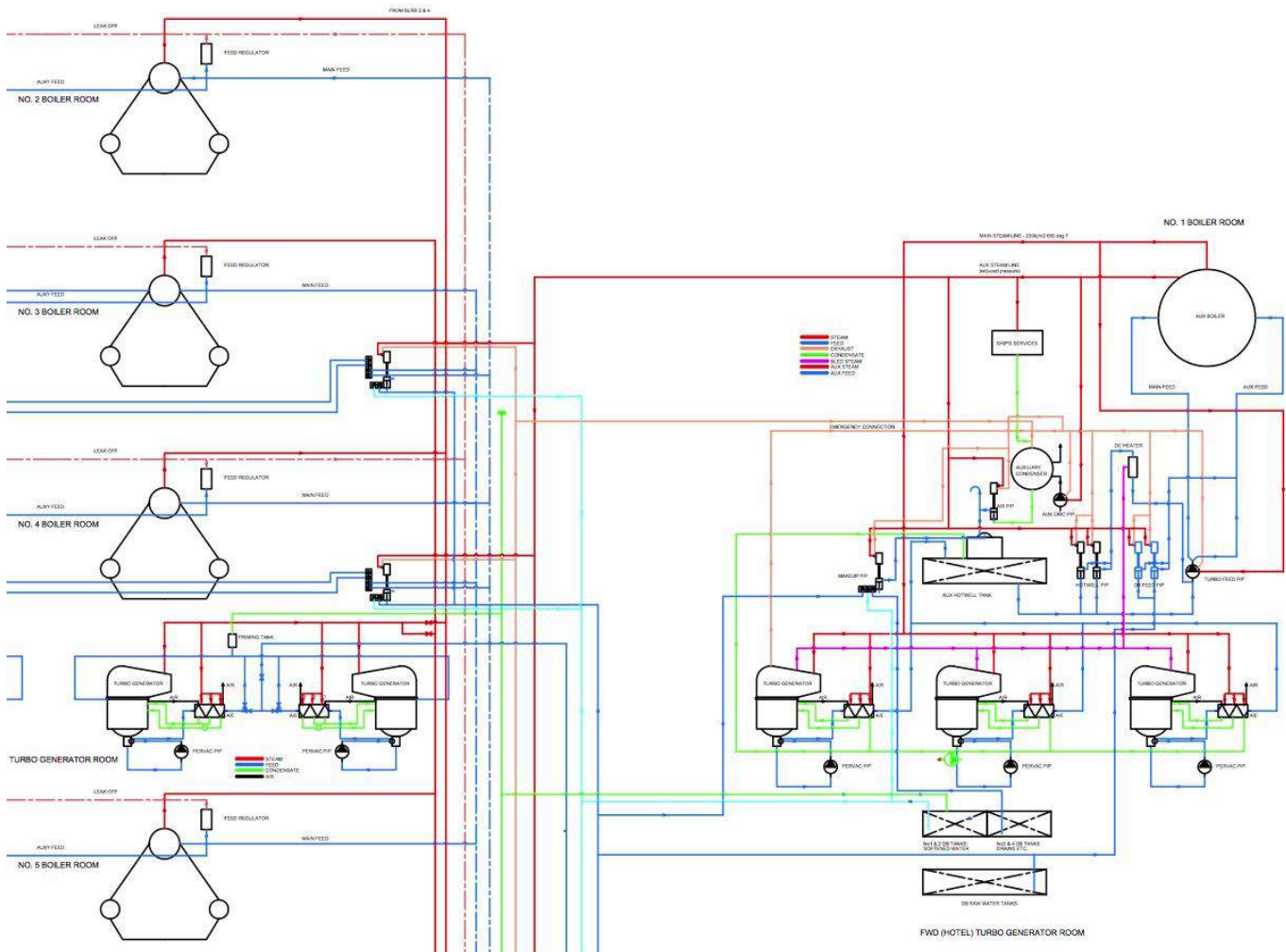

Figure 65 - Auxiliary boiler room No1 and hotel TG room

Here you can see the systems attached to the hotel boiler and TG systems – the auxiliary condenser, Duplex and Simplex double acting steam feed pumps for use with smaller volumes of water, along with the turbo main feed pumps for larger quantities of water once the hotel turbines are running.

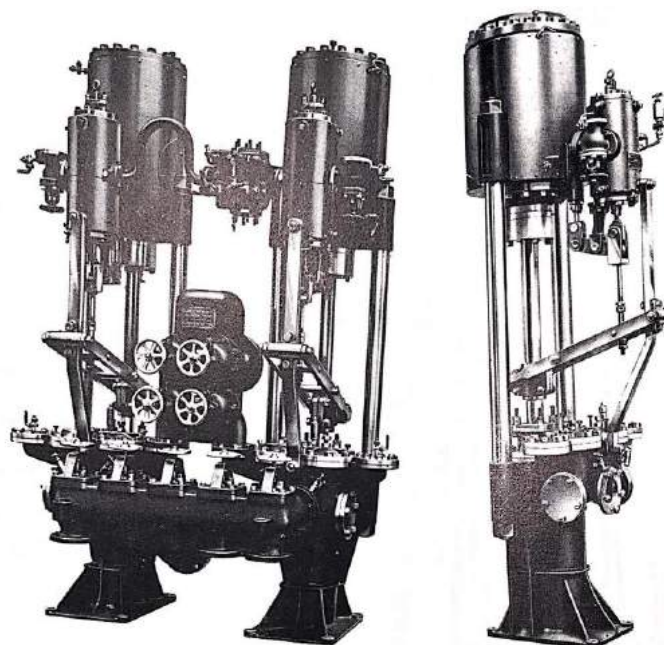

Figure 66 - Duplex and Simplex steam feed pumps

14.3 The steam, feed and condensate system for the whole ship

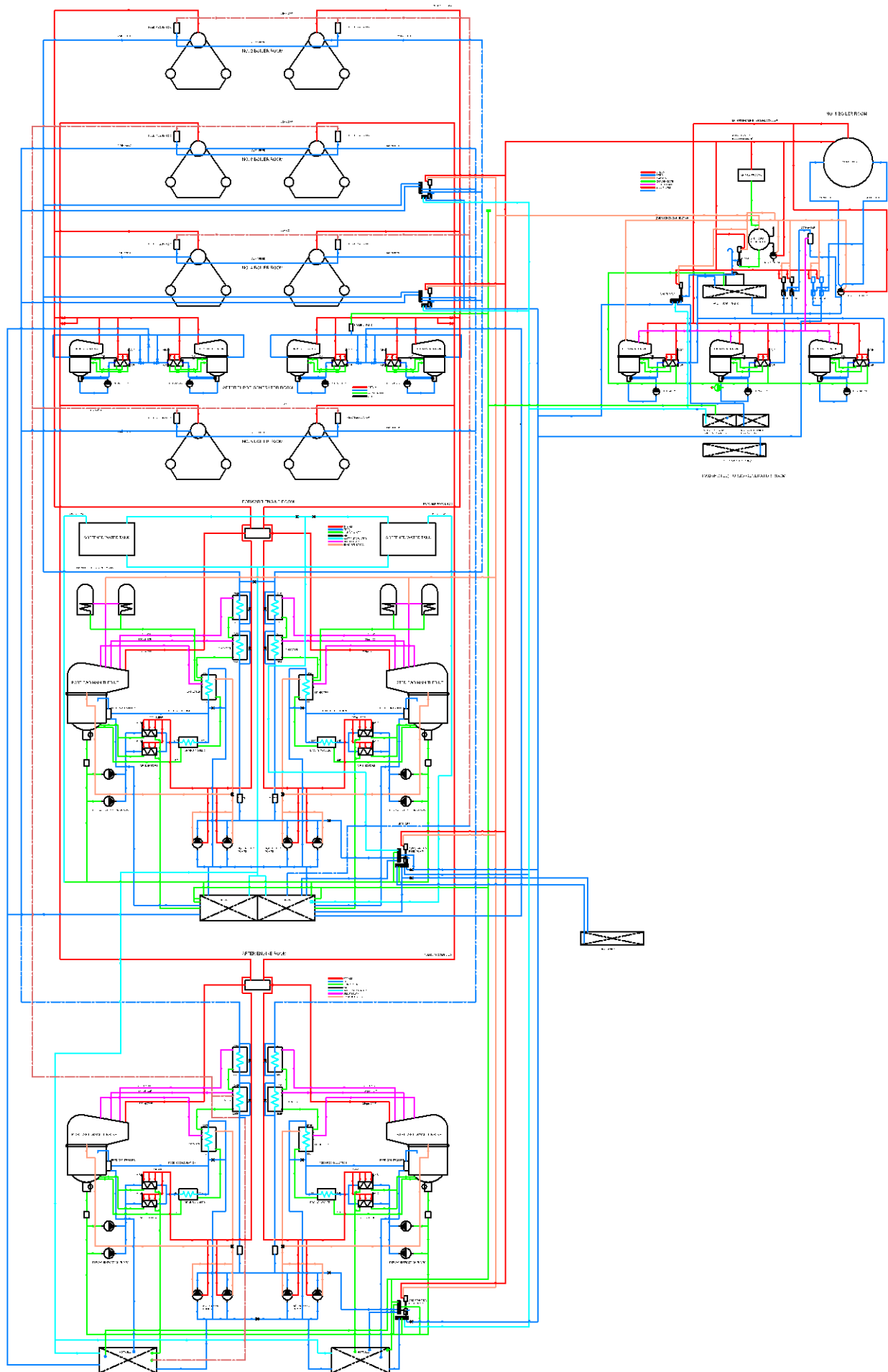

Figure 67 - The complete steam, feed and condensate drawing

14.4 Other views from various web sites

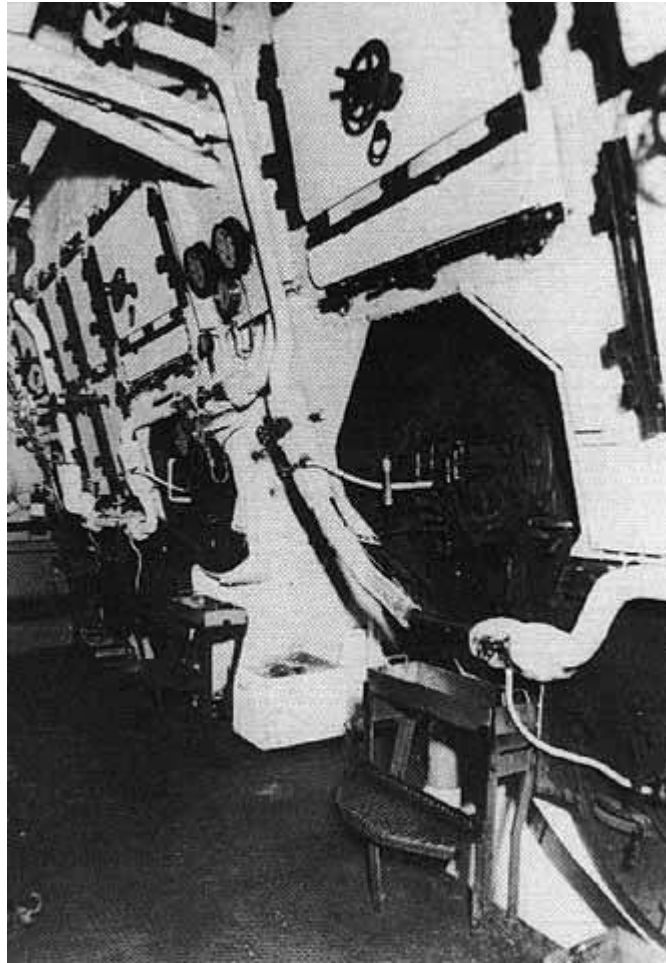

Figure 68 - Boiler Room 1 - burner front of Scotch boiler



Figure 69 - a propulsion boiler in Boiler Room 2 undergoing maintenance

Not a very clean job, and looks more like a coal burner! The smiling worker is inside the furnace peering out of one of the burner throats. Note the large steam pressure gauge.

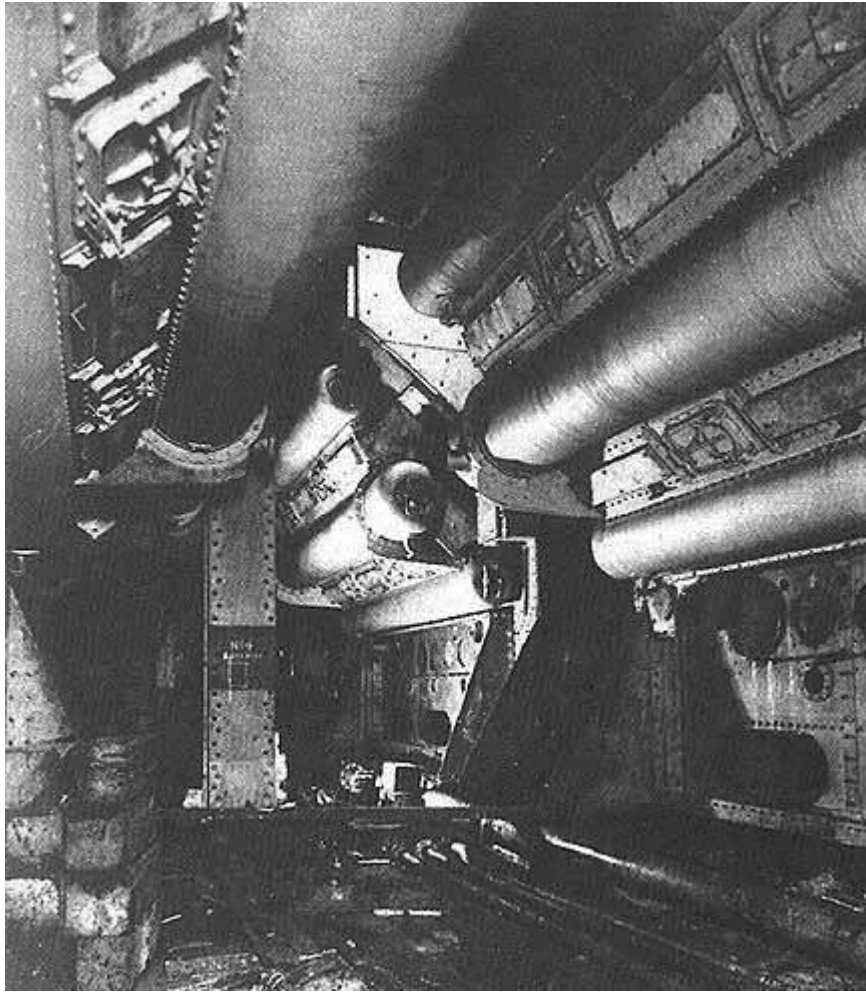

Figure 70 - Boiler room 4 in the process of destruction at Long Beach

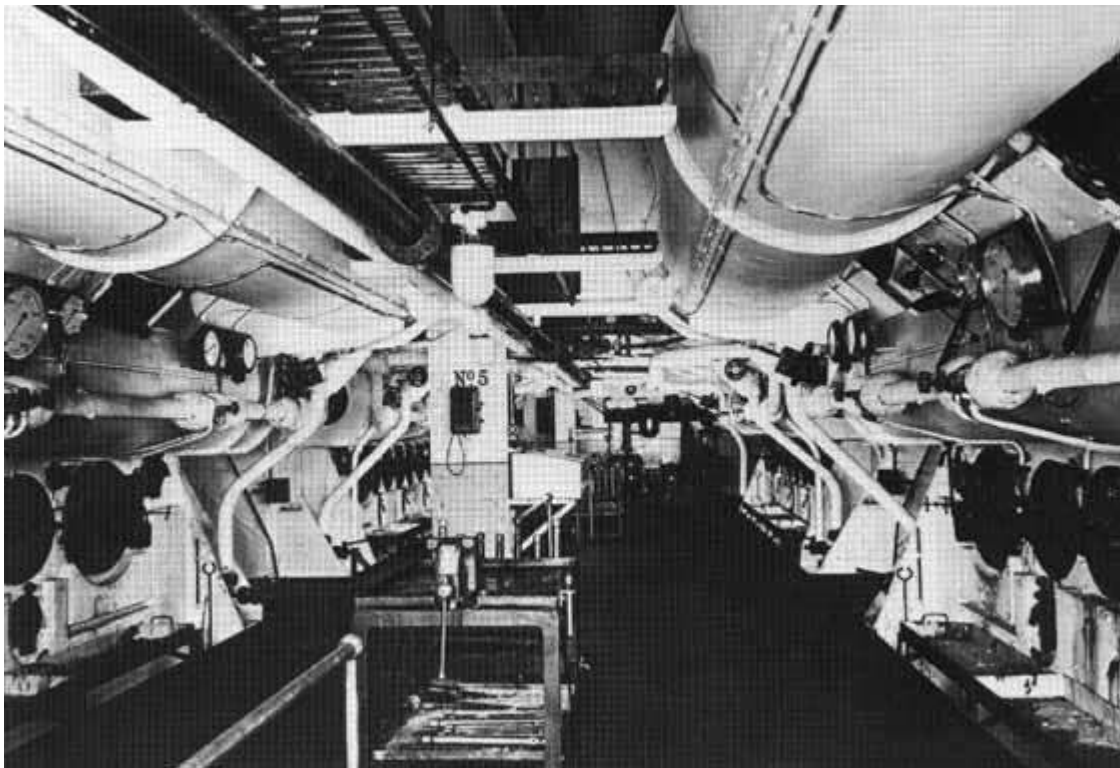

Figure 71 - Boiler Room 5 in good condition

This view shows the furnace fronts facing each other – photo taken looking aft between two of the units.



Figure 72 - The steering Gear room today

This view shows the steering gear ram and the ship's side frames on the right, so this is the port side of the room looking aft.



Figure 73 - The Steering Gear Telemotor showing the hand wheel from the after flying bridge



Figure 74 - The Steering Gear Switchboard